

---

# TomTom GO

# 1. What's in the box

## 1 Your TomTom GO

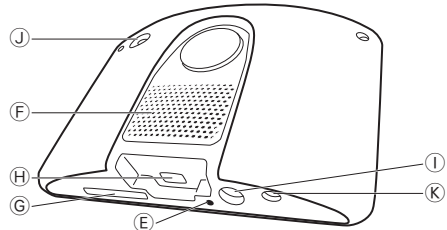
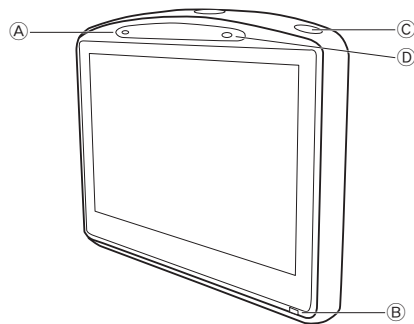

- Ⓐ Microphone
- Ⓑ Charging light
- Ⓒ On/Off button
- Ⓓ Light sensor
- Ⓔ Reset button
- Ⓕ Speaker
- Ⓖ Memory card slot (SD card not included) for optional additional maps
- Ⓗ USB connector
- Ⓘ TomTom connector / RDS-TMC connector
- Ⓙ External antenna connector
- Ⓚ Audio out connector

## 2 Windshield Holder

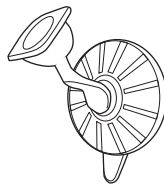

## 3 Documentation pack

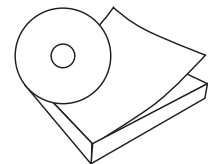

## 4 Car charger

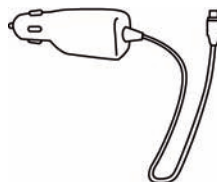

## 5 Home Dock

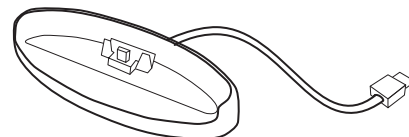

## 6 Adhesive disk for windscreen mount



## Included with TomTom GO 720T and 920T

7 RDS-TMC Traffic Receiver

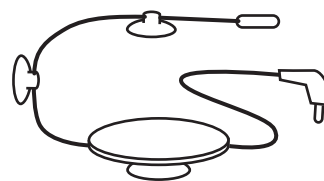

## Included with TomTom GO 920 and 920T

8 Remote control



## 2. Before You Start...

---

### Switching on and off

To switch your TomTom GO on or off, press and hold the On/Off button for 2 seconds. The first time you switch on, it may take a short while for your device to start.

---

**Note:** *In rare cases, your GO may not start correctly. If this happens, press the reset button, then switch on the device again.*

---

### Setting up

To set up your TomTom GO you need to answer a few questions by tapping the screen.

---

**Important:** Take care to select the correct language, since the language you choose will be used for all menus and written instructions.

---

### Battery notes

We recommend that you fully charge your TomTom GO the first time that you connect it to the home dock. It takes up to 2 hours to charge the battery completely.

When you place your GO in the Home Dock, you are asked if you wish to connect to the computer. If you select **No**, the device will switch off if you do not tap the screen for three minutes. This happens so that the battery can recharge at a faster rate.

For information on connecting your computer, see **Using TomTom HOME** (89).

---

**Note:** *Your TomTom GO uses a small amount of battery power to remember the last screen being shown when the device is switched off.*

*If you do not charge your GO for a prolonged period of time, the next time you start your GO it will show the default starting screen. All other device settings will still be maintained.*

---

### Improving reception

If your TomTom GO takes longer than 5 minutes to find your current position, make sure that the device is in an open space away from tall objects such as buildings or trees.

When you connect your TomTom GO to your computer, you can use TomTom HOME to download information about GPS satellite positions during the next 7 days. This helps your GO to find your position faster.

---

**Important:** Some vehicles have heat reflective shielding in the windshield. This may prevent your GO from locating your current position.

The TomTom External Antenna Kit (available for purchase as an accessory) can help to improve reception.

---

## Windshield Holder

Use the windshield holder to install your TomTom GO inside your car.

To attach the holder, press the suction cup firmly to the windshield in your car, in an area of the windshield where the glass is flat.

Make sure that both the holder and your windshield are clean and dry before you attach the holder. Place the holder so that it does not interfere with your view of the road.

## Home Dock

The home dock is used for charging your TomTom GO when it is not in the car and for connecting your GO to your computer.

When connected to your computer, you can use TomTom HOME to manage your GO. For information about TomTom HOME, see **Using TomTom HOME** (89).

## Take care of your TomTom GO

Never leave your TomTom GO or accessories in view when you leave the car or they may become an easy target for thieves.

You can set a password for your TomTom GO which must be entered every time you start your GO. For more information, see **Using TomTom HOME** (89).

It is important to take care of your GO.

- Your GO is not designed for use in extreme temperatures and any such exposure may cause permanent damage.
- Do not open the casing of your GO under any circumstances. Doing so may be dangerous and will invalidate the warranty.
- Wipe or dry the screen of your GO using a soft cloth. Do not use any liquid cleaners.

### 3. Driving View

When your TomTom GO starts, you are shown the Driving View along with detailed information about your current location.

Tap the center of the screen at any time to open the Main Menu.

---

**Note:** The Driving View is shown in black and white until your GO locates your current position.

---



- Ⓐ Tap + and - to zoom in and out.
- Ⓑ Your current position.
- Ⓒ The name of the next major road or road sign information, if applicable.
- Ⓓ Navigation instruction for the road ahead.

Tap this area to repeat the last spoken instruction and to change the volume.

- Ⓔ The name of the next street to turn onto.
- Ⓕ Information about your trip such as trip time, remaining distance and arrival time.

To select what will be shown, tap **Status bar preferences** in the **Preferences** menu.

- Ⓖ GPS signal strength.

- Ⓗ Traffic bar

To set up Traffic information, tap the Traffic bar to open the Traffic menu or tap TomTom **Traffic** in the Main Menu.

- Ⓘ Quick menu - For more information, refer to the full manual.

## 4. Enhanced Positioning Technology

**Note:** Enhanced Positioning Technology is available on the TomTom GO 920 and 920T.

Enhanced Positioning Technology or EPT estimates your location when GPS reception is poor, such as when you drive between tall buildings.

Your GO uses positioning sensors to monitor your acceleration and direction and then estimates your current location.

EPT only helps your GO to estimate your location. Calculating your precise location is only possible when your GO receives a strong GPS signal.

When your GO is using EPT to estimate your location, the EPT icon is shown on the status bar.

Your GO calibrates EPT automatically. If calibration is not complete when your GO loses GPS reception, EPT cannot be used and the screen is shown in grey, for example, when there is no GPS reception at the beginning of a trip.



- Ⓐ EPT icon.
- Ⓑ Your current position.

### Calibration

Calibration is done automatically and requires no interaction from you. However, it is useful to have a basic understanding of the calibration procedure.

Your TomTom GO resets the positioning sensors each time the device is switched on. To help improve accuracy in estimating your location, your GO calibrates the sensors throughout your trip.

The following conditions are required for successful calibration:

- Your GO is receiving a strong GPS signal.
- The car has been stationary for at least 5 seconds and then travels along a straight and level section of road for at least one minute.

## 5. Making your first trip

---

Planning a route with your TomTom GO is easy. To plan your first route, follow the steps below.

---

**Important:** You should always plan your journey before you start driving. It is dangerous to plan a route while driving.

---

1. Tap the screen to bring up the main menu.

---

**Note:** The buttons on your GO are shown in full color unless a button is currently unavailable. For example, the button named **Find alternative...** in the Main Menu is not available until you have planned a route.

---

2. Tap **Navigate to...**

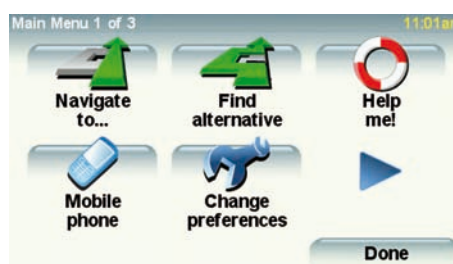

3. Tap **Address**.

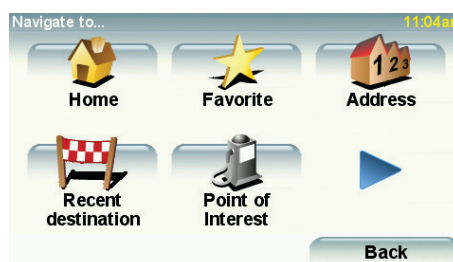

When you enter an address, you can choose from the following options:

- **City center** - tap this button to set your destination as the center of a city or town.
- **Street and house number** - tap this button to set an exact address as your destination.
- **ZIP code** - tap this button to enter a ZIP code as your destination.
- **Cross street or intersection** - tap this button to set your destination as the point where two streets meet.
- **Spoken address** - tap this button to set your destination by announcing the address to your GO. For more information, see **Spoken address** (21).

---

**Note:** Spoken address entry is supported on TomTom GO 920 and 920T.

---



For your first trip, we will enter an exact address.

4. Tap **Street and house number**.

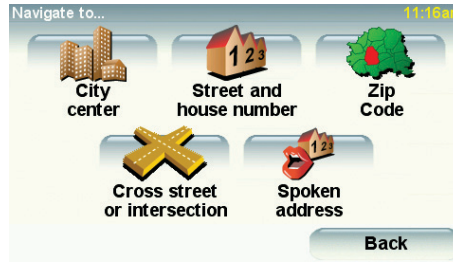

---

**Note:** When planning a trip for the first time your GO asks you to choose a state or country. Your choice is saved and used for all routes you plan.

You can change this setting at any time by tapping the state symbol or country flag.

---

5. Start to type the name of the town where you want to go.



As you type, the names of the towns that match what you have typed are shown. When your destination appears in the list, tap the name of the town to set the destination.



---

**Tip:** Instead of typing the name, tap this button to say the address by speaking to your GO.

For more information, see **Spoken address** (21)

Spoken address entry is supported on TomTom GO 920 and 920T.

---

6. Start to type the name of the street and select it when it is shown.

As with the name of the town, the names of the streets that match what you have typed are shown. When your destination appears in the list, tap the name of the street to set the destination.

7. Now enter the house number of your destination and then tap **Done**.

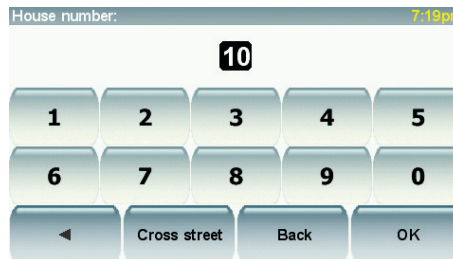

8. Your GO asks if you need to arrive at a particular time. For this exercise, tap **NO**.

The route is calculated by your GO.

9. When the route has been calculated, tap **Done**.

Your GO will immediately begin to guide you to your destination, using both spoken instructions and on-screen directions.



## Arrival times

When you plan a route, your TomTom GO asks you if you need to arrive at a particular time.

Tap **YES** to enter a preferred arrival time.

Your GO calculates your arrival time and shows you whether you will arrive on time.

You can also use this information to work out when you need to leave. If your GO shows that you will arrive 30 minutes early, you can wait and leave in 30 minutes time, rather than arrive early.

Your arrival time is constantly recalculated during your trip. The status bar shows whether you will arrive on time or if you are going to be late, as shown below:

**+55 min**

You will arrive 55 minutes before the arrival time you entered.

If the estimated arrival time is more than five minutes before the time you entered, it is shown in green.

**+3 min**

You will arrive 3 minutes before the arrival time you entered.

If the estimated arrival time is less than 5 minutes before the time you entered, it is shown in yellow.

**-19 min**

You will arrive 19 minutes late.

If the estimated arrival time is later than the time you entered, it is shown in red.



**Status bar preferences**

Tap **Status bar preferences** in the Preferences menu, to enable or disable arrival time notifications.

Select the required options on the first menu screen and then tap **Done**.

To enable arrival time notifications, select **Show leeway to arrival time**.

To disable arrival time notifications, unselect **Show leeway to arrival time**.

## What are the other navigation options?

When you tap **Navigate to...**, you can set your destination in many ways, not just by entering the address. The other options are listed below:



**Home**

Tap this button to navigate to your Home location.

You will probably use this button more than any other.

For information about setting your Home location, see **Change Home location** (52).

---



**Favorite**

Tap this button to select a Favorite as your destination.

For more information about Favorites, see **Favorites** (32).

---



**Address**

Tap this button to enter an address as your destination.

---



**Recent destination**

Tap this button to select your destination from a list of places you have recently used as destinations.

---



**Point of Interest**

Tap this button to navigate to a Point of Interest (POI).

For more information about POIs and navigating to a POI, see **Points of Interest** (38).

---



**GPS position**

Tap this button to select your GPS position, as your destination.

For more information about GPS, see **Global Positioning System (GPS)** (88).

---



**Point on map**

Tap this button to select a point on the map as your destination using the map browser.

For more information about the map browser, see **Driving View** (6).

---



**Latitude Longitude**

Tap this button to enter a destination using latitude and longitude values.

---



**TomTom Buddy**

Tap this button to navigate to the current position of a TomTom Buddy. Don't forget that the Buddy may move before you reach him.

For more information about TomTom Buddies, see **TomTom PLUS** (65).

---



Position of last stop

Tap this button to select your last recorded position, as your destination.

For more information about the GPS, see **Global Positioning System (GPS)** (88).

## Spoken address

---

**Note:** Spoken address entry is available for TomTom GO 920 and 920T.

---

Instead of typing addresses, you can now enter an address by speaking to your GO.

---

**Note:** The speech recognition feature is currently only available for entering addresses and for responding to special notifications.

---



Spoken address

In the Main menu tap **Navigate to...**, then tap **Address**, then tap **Spoken address** or **Spoken address (dialog)** and speak when prompted.

For more information, see **Spoken address** (21)



Spoken address (dialog)

## Planning a route in advance

You can also use your GO to plan trips in advance by selecting both your starting point and your destination. You could, for example, do the following:

- Find out how long a trip is going to take before you start.
- Check the route of a trip you are planning.
- Check a route for someone who is coming to visit you so you can explain the route to them.

To plan a route in advance, follow these steps:

1. Tap the screen to bring up the main menu.
2. Tap the arrow button to move to the next menu screen and tap **Prepare route**.



Prepare route

3. Select the starting point for your trip in the same way that you would select your destination.
4. Set the destination for your trip.
5. Choose the type of route that should be planned.
  - **Fastest route** - the route which takes the least time.

- **Shortest route** - the shortest distance between the locations you set. This may not be the quickest route, especially if the shortest route is through a town or city.
- **Avoid freeways** - a route which avoids freeways.
- **Walking route** - a route designed for making the trip on foot.
- **Bicycle route** - a route designed for making the trip on a bicycle.
- **Limited speed** - a route for a vehicle which can only be driven at a limited speed. You have to specify the maximum speed.

6. Your TomTom GO plans the route between the two locations you selected.

## More information about a route

You can access these options for the route you last planned, by tapping **View route** in the Main Menu.

To find out about your route in detail, tap the **Details** button on the route summary screen.

You can then select from the following options:



**Browse as text**

Tap this button for a list of all the turn instructions on the route.

This is very useful if you need to explain a route to someone else.



**Browse as images**

Tap this button to see each turn in the trip. Tap the right and left arrows to move forwards and backwards through the trip.

Tap the screen to turn off the 3D display and view the map from above.



**Browse map of route**

Tap this button to see an overview of the route using the map browser.

For more information about the map browser, see **Driving View (6)**.



**Show route demo**

Tap this button to watch a demo of the trip. You can interrupt the demo at any time by tapping the screen.



**Show route summary**

Tap this button to open the route summary screen.

## 6. Finding alternative routes

---

Once you have planned a route, you may want to change something about the route, without changing your destination.

### Why change the route?

Maybe for one of these reasons:

- You can see a roadblock or a line of traffic ahead.
- You want to travel via a particular location, to pick someone up, stop for lunch or fill up with gas.
- You want to avoid a difficult intersection or a road you don't like.



Tap **Find alternative...** in the Main Menu to change the route that is currently planned.

Then tap one of the options below.



Tap this button to calculate an alternative to the route already planned.

Your GO will look for another route from your current location to your destination.

If you decide you would prefer to use the original route after all, tap **Recalculate original**.

#### Why would I need to do this?

Apart from the roads near your position and near your destination, the new route will use totally different roads to reach your destination. This is an easy way of calculating a totally different route.



Tap this button if you can see a roadblock or a line of traffic ahead. You then have to choose how much of the route ahead you want to avoid.

Choose from the different options: 100m, 500m, 2000m, 5000m. Your GO will recalculate your route avoiding the section of the route for the distance you selected.

Don't forget that once a new route is calculated, you may have to turn off the road you are on very soon.

If the roadblock suddenly clears, tap **Recalculate original** to return to your original route.



**Travel via...**

Tap this button to change your route so that it passes a particular location, perhaps to pick someone up on the way.

You choose the location you want to pass in the same way as you choose a destination. So you can select from all the same options: for example, **Address, Favorite, Point of Interest** and **Point on map**.

Your GO will calculate a new route to your destination that passes the location you chose.

Using this button, you can only travel via one location. If you want to pass more than one, use an Itinerary. For more information, see **Itinerary planning** (43).



**Recalculate original**

Tap this button to return to the original route without deviations to avoid roadblocks or traveling via particular locations.



**Avoid part of route**

Tap this button to avoid a part of the route. Use this button if you see that your route includes a road or junction you don't like, or which is well-known for traffic problems.

You then choose the road you want to avoid from a list of the roads on your route.



**Minimize traffic delays**

Tap this button to recalculate your route so that it avoids traffic problems as much as possible. Your GO will check if there are any traffic problems on your route and work out the best route to avoid the problems.

For more information about using TomTom Traffic, see **TomTom Traffic** (73).

---

## 7. Sounds and voices

---

The sound on your TomTom GO is used for features such as:

- Spoken instructions
- Hands-free calls
- Warnings
- Music

For information on making hands-free calls on your GO, see **Hands-free calling** (46).

For information on playing music on your GO, see **Music and Media** (26)

### How do I change the volume level?

You can change the volume in three ways:

- Tap the bottom left hand area of the Driving View. The last spoken instruction is repeated and the volume level is shown.  
Move the volume slider to adjust the volume.
- In the Main Menu, tap **Change preferences**, then tap **Volume preferences**.  
Tap **Test** to check your changes.
- You can set your GO to change the volume automatically depending on how noisy it is in the car.

### Changing the volume automatically



Your TomTom GO can change the volume automatically.

1. In the Main Menu, tap **Change preferences**.
2. Tap **Volume preferences**.
3. Select **Link volume to noise level**.
4. Tap **Done**.



## Selecting a voice



### Change voice

To change the voice being used by your TomTom GO, tap **Change voice** in the Preferences menu and select a voice from the list.

Your TomTom GO has two different kinds of voices:

- Computer voices

These are generated by your GO. They provide spoken instructions while you are driving and can pronounce street names and announce messages, traffic reports, weather reports, tips and tutorials.

- Human voices

These are recorded by an actor.

---

**Note:** *Human voices only provide spoken instructions.*

---

## How do computer voices work?

Your TomTom GO makes use of text-to-speech technology to generate computer voices. A text-to-speech program converts written text, for example an instruction like "Turn right", into the sound of a human voice.

The text-to-speech program looks at the whole sentence to make sure that the sound you hear is as close to the real thing as possible. The program is also able to recognize and quite accurately pronounce foreign place and street names. For example, the English voice can read French street names.

---

**Note:** *If you select a Human voice, this will only be able to announce commands, but not street names. If you would like street names to be announced, you will need to select a computer voice.*

---

## Internal and external speakers

Your TomTom GO contains a high quality speaker. This is used to play all the sounds on your GO unless you connect to external speakers.

You can connect external speakers to your GO in the following ways:

- Using an audio cable.

---

**Note:** *If your car stereo has a line-in connector, you can play sound from your GO through your car speakers.*

---

- Connecting a Bluetooth® Hi-Fi headset or speakers.
- Tuning the FM Transmitter in your GO to use your car radio speakers.

## FM transmitter

There is an FM Transmitter inside your GO that works like a radio station. This means you can hear the instructions made by your GO and play your mp3 songs through your car radio speakers.

### Setting up

- In the Main Menu tap **Change preferences**, then tap **Speaker preferences**.

- Switch on your car radio.
- Tune your car radio to a frequency that is not being used by a radio station.
- Tap Change and set the frequency on your GO to the same frequency as your car radio.

If you drive into an area where a radio station transmits on the same frequency you are using for the FM Transmitter, you may have to use another frequency.

## Using more than one speaker

You can select different speakers to be used for specific events, such as using the internal speaker for TomTom GO instructions and external speakers for hearing handsfree phone calls and listening to music.

- Internal speaker
- Bluetooth Hi-Fi device
- Line-out (audio cable)
- FM to your car radio

### Is it difficult to hear spoken instructions when music is playing?

When you choose to use a Bluetooth® Hi-Fi device for music and spoken instructions, you are asked if you want to pause music when spoken instructions are announced. By default, music is always paused for spoken instructions.

When you receive a hands-free phonecall, music is always paused and spoken instructions are not given.

For information about making hands-free calls on your GO, see **Hands-free calling** (46).

## Using the audio cable

To play sound through your car stereo or other external speaker using an audio cable, do the following:

1. Plug the audio cable into the audio out connector on your GO.
2. Plug the audio cable into the line-in connector on your car stereo or other external speaker.

---

**Note:** *Not all car stereos have a line in connector. Check the manual for your car stereo for specific information.*

---

3. If you are using your car stereo, select line-in connector on your car stereo as the input source.
4. On your GO, tap **Speaker preferences** in the Preferences menu.

Tap this button to change the speaker settings.



5. Select the speaker you want your GO to use for announcing instructions.
  - **Internal speaker**

- **Bluetooth Hi-Fi device**
  - **Line-out (audio cable)**
  - **FM to your car radio**
6. Select the speaker you want your GO to use for playing music.
    - **Internal speaker**
    - **Bluetooth Hi-Fi device**
    - **Line-out (audio cable)**
    - **FM to your car radio**
  7. Tap **Done**.
  8. Your GO asks you whether you want to use an external Bluetooth® Hi-Fi speaker. Tap **NO**.

Your GO will confirm that when the device is connected, the sound you have selected will be played through the audio cable.

---

***Note:** You cannot listen to your car stereo and use the audio cable to play sound from your GO on the car stereo at the same time.*

---

For information about listening to music using your GO, see **Music and Media** (26).

## Using Bluetooth® Hi-Fi speakers

Your GO can play sound through Bluetooth® Hi-Fi speakers, such as a Bluetooth® Hi-Fi headset, or a car stereo which uses Bluetooth®.

To play sound over Bluetooth® Hi-Fi speakers, do the following:

1. Tap **Speaker preferences** in the Preferences menu.



Tap this button to change the speaker settings.

2. Select the speaker you want your GO to use for announcing instructions.
  - Internal speaker
  - **Bluetooth Hi-Fi device**
  - **Line-out (audio cable)**
  - **FM to your car radio**
3. Select the speaker you want your GO to use for playing music.
  - **Internal speaker**
  - **Bluetooth Hi-Fi device**
  - **Line-out (audio cable)**
  - **FM to your car radio**
4. Tap **Done**.
5. Your GO asks you to confirm that you want to use an external Bluetooth® Hi-Fi speaker. Tap **YES**.
 

Your GO will start searching for Bluetooth® Hi-Fi devices.
6. Select your Bluetooth® Hi-Fi device from the list of devices found by your GO.
 

Your GO will try to establish a Bluetooth® connection with your device.

Your device may require you to enter a password on your GO before a Bluetooth® connection can be established. See the documentation for your Bluetooth® Hi-Fi device for more information.

Once connected, sound will be played through the external Bluetooth® Hi-Fi device.

If your GO cannot establish a Bluetooth® connection then all sound will be played through the internal speaker or through the audio cable if it is connected to an external audio device with speakers.

## 8. Spoken address

---

---

**Important:** You should always plan your journey before you start driving. It is dangerous to plan a route while driving.

---

When you plan a trip with your TomTom GO, instead of tapping the screen to type in an address, you can use spoken address entry to say the address.

---

**Note:** *Speech recognition is supported on TomTom GO 920 and 920T.*

---



**Spoken address (dialog)**

Tap this button to enter an address using only speech. Using this option, your GO can recognize the following:

- Commands: **Yes, No, Back, Done, OK, Crossing.**
- Street names.
- Place names.
- Numbers: Numbers should be pronounced as individual numerals. For example, to say the number 35, say "Three" and then say "Five."

Using **Spoken address (dialog)**, you can enter information without tapping the screen.



**Spoken address**

Tap this button to enter an address using both speech and by tapping the screen. Using this option your GO can recognize the following:

- Street names.
- Place names.

Using **Spoken address** is typically faster than using **Spoken address (dialog)**.



When this button is shown on the keyboard, you can enter information by speaking instead of typing. Tap this button to enter information using spoken address entry.

---

**Tip:** When this button is shown in grey, you cannot use speech to enter an address.

---

Your GO recognizes place and street names spoken using the local language and pronunciation.

It is not possible to using spoken address entry to say place and street names in all countries.

## Speaking to your TomTom GO

When any of the following symbols are shown on the screen, it is possible to enter information using speech.



**Sound level correct** - When the recording level is shown in green, the device hears your voice at the correct level.



**Sound level low** - When the recording level is shown in yellow, the device has difficulty in hearing your voice. This may mean that you need to speak more loudly or move closer to the device.



**Sound level high** - When the recording level is shown in red, the device has difficulty in hearing your voice. This may mean that there is too much background noise or that you are speaking too loud.

## Planning a trip using spoken address entry

---

**Important:** You should always plan your journey before you start driving. It is dangerous to plan a route while driving.

---

To plan a route using speech, do the following:

1. Tap **Navigate to...** in the Main menu.

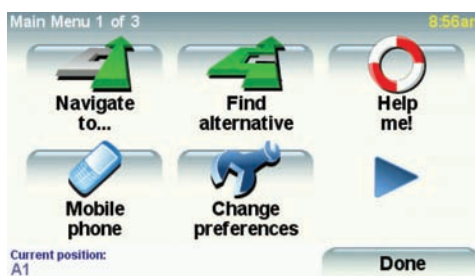

2. Tap **Address**.



For this example, we will navigate to an address using only speech to enter the address.

3. Tap **Spoken address (dialog)**.



4. Say the city name.

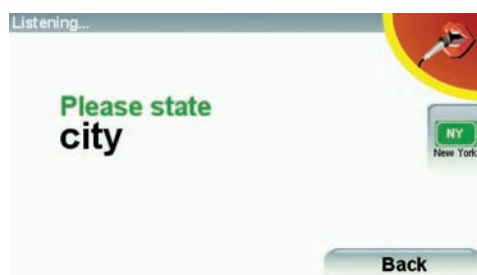

When you say the city name, you are then shown a list of six names that match what you said.

Your GO tells you the name at the top of the list. If the name you hear is correct, then say, "Done" or "OK" or "Yes" or "One" or tap on the name.

If the city name you hear is not correct, but the name appears in the list, then say the number next to the correct name or tap on the correct name.

For example, if the correct name is Rotterdam and this name is number two in the list, you could say, "Two" or tap on the name, Rotterdam.

If the city name is not shown in the list, then say "Back" or "No" or tap the **Back** button to return to the previous screen. Then say the city name again.

---

**Note:** You need to say numbers in the same language that is used for menu buttons.

---

5. Say the street name.

As with the city name, you are then shown a list of six names that closely match what you said.

Your GO tells you the name at the top of the list. If the name you hear is correct, then say, "Done" or "OK" or "Yes" or "One" or tap on the name.

---

**Note:** Different locations may have similar names, such as a road that has multiple postcode locations. In such cases, all of these locations are shown in the list and you need to look at the screen and select the correct location.

---

If the street name you hear is not correct, but the name appears in the list, then say the number next to the correct name or tap on the name.

For example, if the correct name is Rembrandtplein and this name is number three in the list, you could say, "Three" or tap on the name, Rembrandtplein.

For example, looking at the list shown here, if the correct name is Rembrandtplein, you could say, "Two" or tap on the name, Rembrandtplein.

If the street name is not shown in the list, then say "Back" or "No" or tap the **Back** button to return to the previous screen. Then say the street name again.

6. Say the house number.



Numbers should be pronounced as individual numerals, but without waiting in between each digit. For example, you would say the number 357 as one continuous sentence, "Three, five, seven,".

If the number is shown incorrectly, say, "Back" or "No" or tap the Backspace key. Then say the number again.

---

**Tip:** If you say, "Back" when there are no numbers shown on the screen, then your GO will return you to the previous screen.

---

When the number is shown correctly say, "Done" or "OK." Alternatively, enter the number by tapping the screen.

To select a crossroads as the location, say "Crossing".

---

**Note:** You need to say numbers in the same language that is used for menu buttons.

---

7. Your GO asks if you need to arrive at a particular time. For this exercise, tap **NO**.

The route is calculated by your GO.

8. When the route has been calculated, tap **Done**.

## More ways to speak to your TomTom GO

There are various ways to enter an address using speech.

To see the options available, Tap Navigate to... in the Main menu and then tap **Address**.



---

**Note:** Postcode address entry is not possible using speech.

---



- **City center** - to say the center of a city or town, tap this button and then tap the speech button at the bottom of the keyboard on the next screen.
- **Street and house number** - to say an address, tap this button and then tap the speech button at the bottom of the keyboard on the next screen.
- **Cross street or intersection** - to say the point where two streets meet, tap this button and then tap the speech button at the bottom of the keyboard on the next screen.
- **Spoken address** - tap this button to enter an address using speech and by tapping the screen.
- **Spoken address (dialog)** - tap this button to enter an address only using speech. You can still tap the screen for entering certain details if you prefer.

## 9. Music and Media

---

---

**Important:** Only select music and media when you are stationary. It is dangerous to select songs and make adjustments while you are driving.

---

Your TomTom GO can play mp3 audio files and Audible® Audiobooks and display HTML and text documents and photos.

### Putting Music and Photos on Your GO

Transfer music files and photos to your TomTom GO from your computer using TomTom HOME.

For information about using TomTom HOME, see **Using TomTom HOME (89)**

### Playing Music and Audiobooks

1. Tap **Music and media** in the Main Menu.
2. Tap TomTom **Jukebox** to start the Jukebox.

---

**Note:** You can create playlists using a third-party application like iTunes, Musicmatch or Winamp.

---

- **Playlist** - tap this button to select a playlist.
- **Artist** - tap this button to select a song by a particular singer or group.
- **Album** - tap this button to select from a list of all the albums on your GO.
- **Song** - tap this button to select from all the songs on your GO.
- **Genre** - tap this button to select a particular type of music.
- **Audiobooks** - tap this button to select an Audiobook.

---

**Note:** Not all mp3 files contain information about the song, such as the artist or genre. If the file contains no information, the file name is used as the song title.

---

### Now Playing

As soon as you choose a song or Audiobook, your TomTom GO starts playing that song, followed by the rest of the songs in the list.

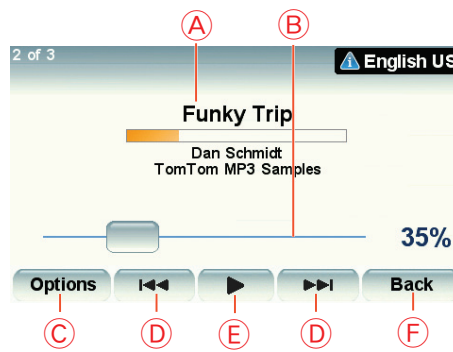

- Ⓐ Information about the song.
- Ⓑ Volume - change the volume by moving the slider.
- Ⓒ The **Options** button. You can, for example, choose to repeat a song and shuffle the songs. You can change these options:
  - **Shuffle songs** - the next song is selected randomly.
  - **Repeat song** - repeat the current song.
  - **Reduce brightness** - brightness is only reduced on the playing screen.
  - **Show music button in Driving View** - enables fast access to your music.
  - **Automatically switch to Driving view** - when a song begins playing, the Driving View is shown.
  - **Slideshow** - your photos are shown while your music is playing..
- Ⓓ Go to the previous or next song.
- Ⓔ Play or Pause the selected song.
- Ⓕ Tap the **Back** button to go back to the TomTom Jukebox player. The music will continue to play unless you tap the button **Playing...** in the Jukebox to stop the music.

When you listen to Audiobooks, you will see buttons for going to the next and previous chapter. When you stop listening to an Audiobook, your GO remembers where you stopped.

To find out more about Audiobooks, go to the shop area in TomTom HOME.

## FM transmitter

There is an FM Transmitter inside your GO that works like a radio station. This means you can hear the instructions made by your GO and play your mp3 songs through your car radio speakers.

### Getting started

- In the Main Menu tap **Change preferences**, then tap **Speaker preferences**.
- Switch on your car radio.
- Tune your car radio to a frequency that is not being used by a radio station.
- Tap Change and set the frequency on your GO to the same frequency as your car radio.

If you drive into an area where a radio station transmits on the same frequency you are using for the FM Transmitter, you may have to use another frequency.

## Using your iPod® with your TomTom GO

You can connect your iPod to your GO with the TomTom iPod Connect Cable, which is available as an accessory.

You can then control your iPod from your GO. Sound from your iPod will be played over the internal speaker in your GO, or an external speaker if selected.

For more information about using different speakers, see **Internal and external speakers** (17).

To use your iPod with your GO, do the following:

1. Plug the iPod Connect Cable into your iPod and into the windshield dock.
2. In the Main Menu, tap **Music and Media** and then **iPod control**.
3. Follow the instructions on the screen to finish the connection.

You can now control your iPod through your GO. You select songs using the same buttons shown above in Playing Music and Audiobooks.

## Looking at Photos

1. Tap **Music and media** in the Main Menu.
2. Tap **Photo gallery**.

The Photo gallery starts, showing small versions (thumbnails) of all the photos on your GO.

Tap the arrows to move up and down the page of thumbnails.

Tap **Slideshow** to start a slideshow.

Tap the thumbnail of a photo to view a large version of that photo.

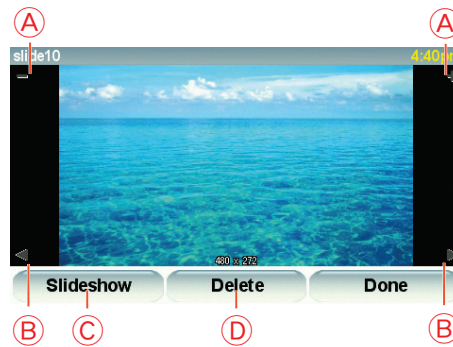

- Ⓐ Buttons to zoom in and zoom out on the photo.
- Ⓑ Buttons to move to the next and the previous photo.
- Ⓒ Tap **Slideshow** to start a slideshow.
- Ⓓ Tap **Delete** to delete a photo.

## 10. Help me!

---

Help me! provides an easy way to navigate to emergency services centers and other specialist services and contact them by phone.

For example, if you are involved in a car accident, you could use Help me! to call the nearest hospital and tell them your exact location.

---

**Tip:** If you do not see the **Help me!** button in the Main Menu, tap **Show ALL menu options** in the Preferences menu.

---

### How do I use Help me! to call a local service?

You can use Help me! to find and make contact with a service center.

When you select a service center, your current location and the phone number of the POI are shown.

If your phone is connected to your GO, your current location and the service center phone number are shown, and your TomTom GO automatically prepares for making a phone call. The phone call will only be dialed, when you tap **Dial**.

If your phone is not connected, your current location and the service center phone number are shown, but your TomTom GO does not prepare for making a phone call.

To use Help me! to locate a service center, contact the center by phone and navigate from your current location to the center, do the following:

1. Tap the screen to bring up the main menu.
2. Tap **Help me!**
3. Tap **Phone for help**.
4. Select the type of service you require, for example, Nearest hospital.
5. Select a center from the list; the nearest is shown at the top of the list.

Your GO shows the location of the service center on the map and the contact details.

6. To navigate your way to the center on foot, tap **Walk there**.

Your GO starts guiding you to your destination.

## Options

---



### Phone for help

Use your TomTom GO to find the location of a service and the contact details.

- **Emergency services**
- **Emergency breakdown services**
- **Nearest police station**
- **Nearest doctor**
- **Nearest hospital**
- **Nearest public transport**
- **Nearest car repair services**
- **Nearest dentist**
- **Nearest pharmacy**
- **Nearest vet**

---

***Note:** In some countries, information may not be available for all services.*

---



### Drive to help

Use your TomTom GO to navigate your way by road to a service center.

- **Nearest car repair services**
- **Nearest hospital**
- **Nearest doctor**
- **Nearest police station**
- **Nearest pharmacy**
- **Nearest dentist**

---

***Note:** In some countries, information may not be available for all services.*

---



### Walk to help

Use your TomTom GO to navigate your way on foot to a service center.

- **Nearest gas station**
- **Nearest public transport**
- **Nearest police station**
- **Nearest pharmacy**
- **Home**
- **Nearest doctor**

---

***Note:** In some countries, information may not be available for all services.*

---



### Where am I?

Your TomTom GO shows your current location.

You can then tap **Phone for help** to select the type of service you want to contact.

---



**First Aid  
Guide**

Tap this button to read the British Red Cross First Aid guide.



**Other guides**

Tap this button to read a selection of useful guides.

---

## 11. Favorites

---

### What are Favorites?

Favorites are places that you often visit. You can create Favorites so that you don't have to enter the address every time you want to navigate there.

They don't have to be places you especially like, just useful addresses.

### How can I create a Favorite?

From the Main Menu, tap **Add Favorite**.

---

**Note:** The button **Add Favorite** may not be shown on the first page of the Main Menu. Tap the arrow to open other pages in the Main Menu.

---

You can then select the location of the Favorite from the list below.

Give your Favorite a name that is easy to remember. Your GO will always suggest a name, usually the address of the Favorite. To enter the name, just start typing. You don't have to delete the suggested name.



Home

You can set your Home location as a Favorite.



Favorite

You cannot create a Favorite from another Favorite. This option will always be unavailable in this menu.

To rename a Favorite, tap **Manage Favorites** in the Preferences menu.

For more information, see **Manage Favorites** (52).



Address

You can specify an address to be a Favorite. When you enter an address, you can choose from four options.

- **City center**
  - **Street and house number**
  - **ZIP code**
  - **Crossing or intersection**
-





**Recent destination**

Select a Favorite location from a list of places you have recently used as destinations.



**Point of Interest**

You can add a Point of Interest (POI) as a Favorite.

**Does it make sense to do this?**

If you visit a POI you particularly like, for example a restaurant, you can add it as a Favorite.

To add a POI as a Favorite, tap this button, then do the following:

1. Narrow your choice of POIs by selecting the area where the POI is.

You can select one of these options:

- **POI near you** - to search from a list of POIs near your current position.
- **POI in city** - to choose a POI in a particular town or city. You have to specify a town or city.
- **POI near Home** - to search from a list of POIs near your Home location.

If you are currently navigating to a destination, you can also select from a list of POIs which are on your route or near your destination. Choose one of these options:

- **POI along route**
- **POI near destination**

2. Select the category of POI.

Tap the category of POI if it is shown or tap the arrow to choose from the complete list.

Tap **Any POI category** to search for a POI by name.

For more information about POIs, see **Points of Interest** (38).



**My location**

Tap this button to add your current position as a Favorite.

For example, if you stop somewhere interesting, while you are there you can tap this button to create the Favorite.



**Point on map**

Tap this button to create a Favorite using the map browser.

Select the location of the Favorite using the cursor, then tap **Done**.

For more information about the map browser, see **Browse map** (36).



**Latitude Longitude**

Tap this button to create a Favorite by entering latitude and longitude values.

---



Tap this button to make a Favorite of the current position of a TomTom Buddy.

For more information about TomTom Buddies, see **TomTom PLUS** (65).

---



Tap this button to select your last recorded position as your destination.

For more information about the GPS, see **Global Positioning System (GPS)** (88).

---

## How can I use a Favorite?

You will normally use a Favorite as a way of navigating to a place without having to enter the address. To navigate to a Favorite, do the following:

1. Tap the screen to bring up the main menu.
2. Tap **Navigate to...**
3. Tap **Favorite**.
4. Select a Favorite from the list.

Your GO calculates the route for you.

5. When the route is calculated, tap **Done**.

Your GO will immediately start guiding you to your destination with spoken instructions and visual instructions on the screen.

## How many Favorites can I create?

You can create up to 48 Favorites. If you want to add more than 48, we suggest that you make some POI categories and add some of your Favorites as POIs.

For more information about POIs, see **Points of Interest** (38).

## How can I delete a Favorite?

1. Tap the screen to bring up the main menu.
2. Tap **Change preferences** to open the Preferences menu.
3. Tap **Manage Favourites**.

---

**Tip:** Tap the arrow to move to the next page.

---

4. Tap the Favorite you want to delete.
5. Tap **Delete**.

## How can I change the name of a Favorite?

1. Tap the screen to bring up the main menu.
2. Tap **Change preferences** to open the Preferences menu.
3. Tap **Manage Favorites**.

---

**Tip:** Tap the arrow to move to the next page of buttons.

---

4. Tap the Favorite you want to rename.

5. Tap **Rename**.

## 12. Browse map

To look at the map in the same way as you might look at a traditional paper map, tap **Browse map** in the Main Menu.

You can move the map by touching the screen and moving your finger across the screen.

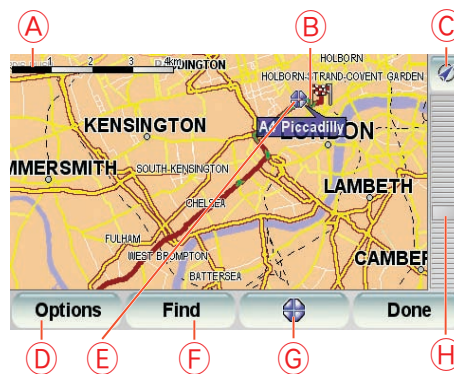

Ⓐ The scale bar

Ⓑ Your current position.

Ⓒ GPS button

Tap this button to center the map on your current position.

Ⓓ Options

Ⓔ The cursor

Ⓕ The Find button

Tap this button to find specific addresses.

Ⓖ The Cursor button

Tap this button to navigate to the cursor position, make a Favorite of the cursor position, or find a Point of Interest near the cursor position.

Ⓗ The zoom bar

Zoom in and out by moving the slider.

### Cursor button

You can use the map to find addresses and Points of Interest (POIs), for example, restaurants, train stations and gas stations.

Tap the cursor button then tap one of the following buttons:



Tap this button to navigate to the cursor position. Your GO will calculate the route.



Tap this button to find a POI near the cursor position. For example, if you have found a restaurant to go to, you can search for a parking garage nearby.



Tap this button to bring the location currently highlighted by the cursor to the center of the screen when looking at the map.



Tap this button to call the location at the cursor position. This button is only available if your GO has the phone number for the location.

The phone numbers of many POIs are stored in your GO. If you enter phone numbers for POIs that you create, you can also call them.

For more information about hands-free calling, see **Hands-free calling** (46).



Tap this button to create a Favorite at the cursor position.

For more information about Favorites, see **Favorites** (32).



Tap this button to create a POI at the cursor position.

For more information about POIs, see **Points of Interest** (38).



Tap this button to correct the location shown at the cursor position.

---

## 13. Points of Interest

---

Points of Interest or POIs are useful places on the map. Here are some examples:

- Restaurants
- Hotels
- Museums
- Parking garages
- Gas stations

### Showing POIs on the map

1. Tap **Show POIs on map** in the Preferences menu.



2. Select the POI categories to display on the map.

Tap **Find** to search for a POI by name.

3. Tap **Done**.

The POIs you have selected are shown as symbols on the map.

### Calling a POI

Your TomTom GO knows the phone numbers for many POIs. You can, for example, call a restaurant to book a table.

For information about using your TomTom GO for hands-free calling, see **Hands-free calling** (46).

### Navigating to a POI

You can use a POI as your destination. For example, if you are traveling to an unfamiliar city, you could choose a POI to help find a parking garage.

1. Tap the screen to bring up the main menu.
2. Tap **Navigate to...** in the Main Menu.
3. Tap **Point of Interest**.
4. Tap **POI in city**.
5. Narrow your choice of POIs by selecting the area where the POI is located.

You can select one of these options:

- **POI near you** - to choose from a list of POIs near to your current location.
- **POI in city** - to find a POI in a particular town or city.
- **POI near Home** - to choose from a list of POIs near to your Home location.

You can select from a list of POIs which are along your route or close to your destination. Choose from one of these options:

- **POI along route**
- **POI near destination**

6. Type the name of the town you want to visit and select the town when it appears in the list.

7. Tap **Parking garage**.

8. Select the category of POI:

Tap **Any POI category** to search for a POI by name.

Tap the category of POI, if it is shown.

Tap the arrow to choose from the complete list of categories. Select the category from the list or start to type the name of the category and select it when it appears in the list.

9. Select a parking garage. The distance listed next to each POI is the distance from the city center.

10. From the list of POIs shown, select the POI you want to navigate to.

The table below explains the distances listed next to each POI.

|                      |                                      |
|----------------------|--------------------------------------|
| POI near you         | Distance from your current location  |
| POI in city          | Distance from the city center        |
| POI near Home        | Distance from your Home location     |
| POI along route      | Distance from your current location  |
| POI near destination | Distance from your destination       |
| Last POI             | Distance to the last POI you visited |

If you know the name of the POI, tap **Find** and type the name. Select it from the list when it is shown.

11. Select a parking garage. The distance listed next to each POI is the distance from the city center.

Once you have selected a POI, the route to the POI is calculated by your TomTom GO.

The route to the POI is then calculated by your TomTom GO.

## Managing POIs



Manage POIs

Tap **Manage POIs** from the Preferences menu.

---

**Note:** The **Manage POIs** button is only available when all menu buttons are shown. To show all menu buttons, tap **Show ALL menu options** in the Preferences menu.

---

You can, for example, do the following:

- Create your own POI categories and add POIs to them.
- Set warnings when you get close to POIs.

### Why would I want to create my own POIs?

A POI acts like a shortcut - once you have saved a location as a POI you never have to type the address of that POI again. But when you create a POI you can save more than just the location.

- Phone number - when you create a POI, you can save a phone number with it.
- Categories - when you create a POI you have to put it in a category.

For example, you could create a category of POIs called 'Favourite restaurants'. With each POI, save the phone number so that you can call them from your GO to reserve a table.

## How can I create my own POIs?

1. Tap the screen to bring up the main menu.
2. Tap **Change preferences**.
3. Tap **Manage POIs**.
4. Before you can add a POI, you have to create at least one POI category. Every POI is assigned to a POI category. You can only add POIs to POI categories you have created yourself.



Add POI category

Tap **Add POI category**.

5. Enter a name for your POI category, for example, 'Friends' or 'Favourite restaurants'. Then select a marker for your POI category.
6. Tap **Add POI**.



Add POI

Tap this button to add a POI.

7. Select the POI category in which you want to add the POI.



8. Select the location of your POI from the list below.



Home

You can set your Home location as a POI.

If you want to change your Home location, you can create a POI of the Home location before you change it.



Favorite

You can create a POI from a Favorite.

You can only create a limited number of Favorites. If you want to create more Favorites you have to delete some Favorites first. Before you delete a Favorite, make it into a POI so that you don't lose the address.



Address

You can specify an address to be a POI. When you enter an address, you can choose from four options.

- **City center**
- **Street and house number**
- **ZIP code**
- **Crossing or intersection**



Recent destination

Select a POI location from a list of places you have recently used as destinations.



Point of Interest

You can add a Point of Interest (POI) as a POI. For example, if you are creating a category of POIs for your favourite restaurants, use this option instead of entering the addresses of the restaurants.



My location

Tap this button to add your current position as a POI.

For example, if you stop somewhere you like, while you are there you can tap this button to create the POI.



Point on map

Tap this button to create a POI using the map browser.

Select the location of the POI using the cursor, then tap **Done**.

For more information about the map browser, see **Driving View** (6) and **How can I create my own POIs?** (40)



Latitude Longitude

Tap this button to create a POI by entering latitude and longitude values.



TomTom Buddy

Tap this button to make a POI of the current position of a TomTom Buddy.

For more information about TomTom Buddies, see **TomTom PLUS** (65).



Tap this button to select your last recorded position as your destination.

This may be useful if your GO is unable to maintain a strong GPS signal, for example, when you drive through a long tunnel.

For more information about the GPS, see **Global Positioning System (GPS)** (88).

---

## How can I set warnings for POIs?

1. Tap the screen to bring up the main menu.
2. Tap **Change preferences**.
3. Tap **Manage POIs**.

---

**Note:** The **Manage POIs** button is only available when all menu buttons are shown. To show all menu buttons, tap **Show ALL menu options** in the Preferences menu.

---

4. Tap **Warn when near POI**.



Tap this button to receive a warning when you travel near to the location of a POI.

5. Select the category of POI you want to be warned about.

Select the category from the list or start to type the name of the category and select it when it is shown in the list.

6. Set how close the POI should be when you receive a warning.
7. Choose the warning sound for the category of POI you selected.

## 14. Itinerary planning

---

### What is an Itinerary?

An Itinerary is a plan for a trip including more locations than your final destination.

An Itinerary can include the following items:

- Destination - a location on your trip where you want to stop.
- Waypoint - a location on your trip you want to travel through without stopping.

Here's an example of an Itinerary:

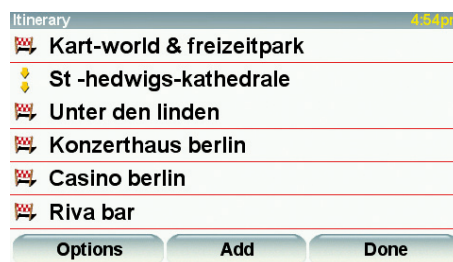

Destinations are shown using this symbol.



Waypoints are shown using this symbol.

### When would I use an Itinerary?

You could use an Itinerary for trips such as:

- A road trip through a country with lots of stops.
- A two day car trip with an overnight stop.
- A short drive which passes by Points of Interest.

In all these examples you could tap **Navigate to...** for each place. However, if you use an Itinerary, you can save time by planning everything in advance.

### Creating an Itinerary

1. Tap the screen to bring up the main menu.
2. Tap **Itinerary planning**.



The Itinerary planning screen opens. At first, there are no items on the Itinerary.

---

**Note:** This button may only be available if all menu options are shown. To show all menu options, tap **Show ALL menu options**.

For more information, see **Hidden buttons and features (49)**.

---

3. Tap **Add** and select a location.

---

**Tip:** You can add items to your Itinerary in any order and rearrange the order later.

---

## Start Using an Itinerary

Tap **Options**, then tap **Start navigation**.

To save an Itinerary, tap **Save Itinerary**.

To load a saved Itinerary, tap **Load Itinerary**.

To create a new Itinerary, tap **New Itinerary** and to delete one, tap **Delete Itinerary**.

## Following an Itinerary

When you use an Itinerary to navigate, the route will be calculated to the first destination on the Itinerary. Your TomTom GO calculates the remaining distance and time to the first destination and not for the whole Itinerary.

As soon as you start to use an Itinerary, the route is calculated from your current position. You do not need to set a departure point.

When you have passed a waypoint or reached a destination, it is marked as visited.

Waypoints are shown on the map. Your GO will not warn you when you are approaching a waypoint or when you arrive at a waypoint.

## Managing an Itinerary

Tap an item on your Itinerary to open a menu of buttons for editing the item. The buttons shown below are available.



---

You can change a destination into a waypoint using this button.

Waypoints are locations you want to pass through on your way to your chosen destination(s).

Destinations are locations where you want to stop.

This button is only shown if the item you tapped is a destination.

---



**Mark as destination**

You can change a waypoint into a destination using this button.

Waypoints are locations you want to pass through on your way to your chosen destination(s).

Destinations are locations where you want to stop.

This button is only shown if the item you tapped is a waypoint.

---



**Mark 'visited'**

Tap this button to miss out part of your Itinerary. Your GO will ignore this item and all the items before it in the Itinerary.

It will navigate you to the next item in the Itinerary.

This button is only shown if you are still due to visit this item.

---



**Mark 'to visit'**

Tap this button to repeat part of your Itinerary. Your GO will navigate you to this item followed by the rest of the items in the Itinerary.

This button is only shown if you have already visited this item.

---



**Move item up**

Tap this button to move the item up the Itinerary.

This button is unavailable if the item is at the top of the Itinerary.

---



**Move item down**

Tap this button to move the item down the Itinerary.

This button is unavailable if the item is at the bottom of the Itinerary.

---



**Show on map**

Tap this button to see the location of the item on the map.

For more information about the map browser, see **Driving View (6)**.

---



**Delete item**

---

Tap this button to delete the item from the Itinerary.

## 15. Hands-free calling

---

### Hands-free calling

If you have a mobile phone with Bluetooth®, you can use your TomTom GO to make phone calls and send and receive messages.

---

**Note:** *Not all phones are supported or compatible with all features. For more information, visit [www.TomTom.com/phones](http://www.TomTom.com/phones)*

---

### Connecting to Your Phone

First you must establish a connection between your mobile phone and your TomTom GO.

Tap **Mobile phone** in the **Main Menu** and then follow the instructions on the screen.

You only need to do this once, after which your TomTom GO will remember your phone.

### Setting up TomTom Services

When you have established a connection with your phone, you can set up a wireless data connection for TomTom Services.

For information about TomTom Services, see **TomTom PLUS** (65).

---

#### Tips

- Make sure that you switch on Bluetooth® on your phone.
- Make sure that your phone is set to "discoverable" or "visible to all".
- You may have to enter the password '0000' on your phone in order to connect to your TomTom GO.
- Make your TomTom GO a trusted device on your phone. Otherwise you will have to enter '0000' every time.

See your phone's user guide for information about Bluetooth® settings.

---

### Your Phone Book

You can copy your phonebook from your mobile phone to your TomTom GO so that you can make calls with just a few taps on the screen.

This is the safest way to make hands-free calls.

---

**Note:** You can copy your phonebook to your TomTom GO at any time. From the Mobile phone menu, tap **Get numbers from phone**.

Not all phones can transfer their phonebook to your GO. For more information, visit [www.TomTom.com/phones](http://www.TomTom.com/phones)

---

## Making a Call

Once you have established a connection with your phone, you can start making calls.

1. Tap **Mobile phone** in the Main Menu.
2. Tap **Call**.

---

**Note:** Make sure that your phone is currently selected. The current phone is shown at the bottom of the screen.

---

3. Tap **Number** to enter a number to call.
4. Do one of the following:
  - Tap **Home** to call your Home location. If you have not entered a number for your Home location this button is unavailable. To enter a number, tap **Change Home number** in the **Phone preferences** menu.
  - Tap **Number** to enter a number to call.
  - Tap **Point of Interest** to choose a Point of Interest (POI) to call. If your GO knows the phone number of a POI, this is shown next to the POI.
  - Tap **Phonebook entry** to select a contact from your phonebook.

---

**Note:** If you have not copied your phonebook to your TomTom GO, the button **Phonebook entry** is unavailable.

---

- Tap **Recently dialed** to select from a list of people or numbers you have called recently using your GO.
- Tap **Recent caller** to select from a list of people or numbers who called you recently. Only calls you have received on your GO are saved in this list.

For information about POIs, see **Points of Interest** (38).

## Receiving a Call

If someone calls you while you are driving, accept or reject the call by tapping the screen.

## Auto-Answer

You can tell your TomTom GO to answer every call automatically after a certain time. Tap **Phone preferences** in the mobile phone menu, then tap **Auto-answer preferences**.

Select when your TomTom GO will automatically answer your calls.

## Sharing your TomTom GO

To add more phones, do the following. You can establish connections for up to 5 mobile phones.

1. Tap **Mobile phone** in the Main Menu.
2. Tap **Connect to your phone**.

3. Tap **Find other phone...** and follow the instructions on the screen.

To switch between phones, tap **Connect to your phone** and then select your phone from the list.

The available buttons are listed below:



Tap this button to redial a telephone number using your mobile phone.



Tap this button to read or write a message.



Tap this button to configure how your TomTom GO communicates with your mobile phone.



Tap this button to dial a telephone number using your mobile phone.



Tap this button to load the contacts and phone numbers from your mobile phone onto your TomTom GO.



Tap this button to manage the mobile phones that will be connected to your TomTom GO. You can add a profile for up to five different mobile phones.

---



## 16. Preferences

---

You can change the way your TomTom GO looks and behaves.

Tap **Change preferences** in the Main Menu.

### Hidden buttons and features

When you first start using your TomTom GO, all the buttons are shown in the menu.

The buttons for the more advanced features can be hidden. This is a useful option because you are unlikely to use certain features very often.



**Show fewer menu options**

Tap this button in the Preferences menu, to reduce the number of buttons that are shown.

You might want to do this so that only frequently used buttons are shown.

When you need to use the buttons that are hidden, you can press **Show ALL menu options** in the Preferences menu to show all buttons.



**Show ALL menu options**

Tap this button in the Preferences menu, to show all the buttons available on your TomTom GO.

### Use night colors / Use day colors



**Use night colors**

Tap this button to reduce the brightness of the screen and show darker colors on the map.

#### When should I use this?

When it's dark, it is easier to see the screen if the display on your GO is not brightly lit.



**Use day colors**

To change back to a brighter screen showing brighter colors on the map, tap **Use day colors**.

#### Can my GO make this change automatically?

Yes. Your GO has a light sensor to tell when it is getting dark.

To change to night and day colors automatically, tap **Brightness preferences** in the Preferences menu. Then select **Switch to night view when dark**.

## Show POI on map



Tap this button to set which categories for the Points of Interest (POIs) should be shown on the map.

Select the POIs that you want to see on the map from the list.

When you select a POI, it is shown on the map using the symbol you can see next to each category in the list.

To find a POI category quickly, tap **Find**, then start to type the name of the POI category. As soon as the category is shown in the list, you can select it.

For more information about POIs, see **Points of Interest** (38).

## Safety preferences



Tap this button to set the following safety preferences:

- **Hide most menu options while driving**
- **Suggest driving breaks**
- **Show safety reminders**
- **Warn when near places of worship or schools**
- **Warn when driving faster than allowed**
- **Warn when driving faster than a set speed**
- **Warn not to leave the device in the car**

If you select one or more of the warnings, you will also be asked to select a sound to be played whenever a warning is displayed.

Select whether or not your TomTom GO should warn you about which side of the road you should be driving on.

Decide if you want the map display to be turned off in special circumstances and press **Done**.

### What happens when I use the Turn off map display option?

When you turn off the map display, instead of seeing your position on a map in the Driving View, you will only see information about the next instruction.

Tap the button and select an option for when the map should be turned off. These are the options:

- **Always** - The map will not be shown and you will only see information about the next instruction and arrows showing direction.
- **Above a certain speed** - you set the speed at which point the map will be turned off. This option is useful for situations when the map might be distracting, such as when you are driving fast.
- **Never** - the map is never turned off.

## Voice preferences



**Voice preferences**

Tap **Voice preferences** to manage your TomTom voices. The following options are available:

- **Change voice** - tap this button to change the voice that gives you instructions.  
A wide range of recorded human voices and computer voices are available.  
For more information on choosing a voice and the differences between human and computer voices, see **Selecting a voice** (17).
- **Disable voice** - tap this button to disable the use of voices. To enable voices, tap **Enable**.
- **Speech preferences** - tap this button to set the situations when your TomTom will read instructions or warnings aloud.
- **Record voice** - tap this button to record your own voice for use by your TomTom. The procedure takes about fifteen minutes, during which time you will say all the commands that are used by your TomTom GO.

In the Preferences menu, tap **Voice preferences**, then tap **Record voice** and follow the instructions for recording your voice.

- **Disable recorded voice**
- **Enable recorded voice**
- **Download voice** - tap this button to download new voices from TomTom Services and transfer them to your TomTom.

## Turn off sound / Turn on sound



**Turn off sound**

Tap this button to turn off spoken instructions.

The button changes to **Turn on sound**. If you turn off the sound, warnings for upcoming POIs are also turned off.

---

### Tips

To change the volume, tap **Volume preferences** in the Preferences menu.

For more information, see **Volume preferences** (52).

To change the volume quickly while you are driving, tap the bottom left-hand section of the Driving View and move the slider.

You can still listen to music even if you have turned off voice instructions.

For more information, see **Selecting a voice** (17).

---

### Can I still use my GO to make hands-free calls when the sound is turned off?

Yes. Turning the sound off does not affect hands-free calling, meaning that you will still be able to talk to and hear the caller.

## Volume preferences

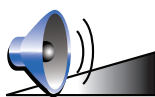

**Volume preferences**

Tap this button to change the volume for spoken instructions.

This setting does not change the volume of the radio, CDs, or music played from an iPod® or USB storage device.

### Can my GO change the volume depending on how noisy it is in the car?

Select **Link volume to noise level** and your GO will change the volume according to the background noise. The noise level is constantly monitored by the microphone on your GO. If there is a lot of noise in the car, your GO will automatically increase the volume.

For example, if you are driving on the motorway, which is often very noisy, the volume level on your GO will be increased. When you are driving more slowly again, the volume level will be lowered by your GO.

## Manage Favorites



**Manage Favorites**

Tap this button to rename or delete Favorites.

To find a Favorite quickly, tap **Find**, then start to type the name of the Favorite. As soon as the Favorite is shown in the list, you can select it.

For more information about Favorites, see **Favorites (32)**.

## Change Home location



**Change Home location**

Tap this button to set or change your Home location.

### Do I need to use my actual home address for the Home location?

No. Your Home location can be a place you go often, for example, your office. It can be your actual home address, but it can also be any address you like.

### Why should I set a Home location?

Having a Home location means that you have a quick and easy way to navigate there, by tapping the Home button in the **Navigate to...** menu

## Manage maps

---

This button may only be available if all menu options are shown. To show all menu options, tap **Show ALL menu options**.

For more information, see **Hidden buttons and features (49)**.

---



### Manage maps

Tap this button to do the following:

- **Download a map** - you can buy new maps using TomTom HOME.  
For more information, see **Using TomTom HOME** (89).
- **Switch map** - tap this button to change the map you are using.
- **Delete a map** - tap this button to delete a map. This might be necessary to create more space on your GO, for example when you want to load a different map.

---

***Note:** Don't delete a map unless you have already made a backup of the map. If you delete a map before you make a backup, you will no longer be able to load the map on your GO.*

---

For more information about making a backup, see **Using TomTom HOME** (89).

You can also download, add and delete maps using TomTom HOME.

### Manage POIs

---

This button may only be available if all menu options are shown. To show all menu options, tap **Show ALL menu options**.

For more information, see **Hidden buttons and features** (49).

---



### Manage POIs

Tap this button to do the following:

- Set alerts for when you are near POIs.  
For example, your GO can tell you when there is a gas station nearby.
- Create your own POI categories and add POIs to them.

For example, you could create a category of POIs called "Friends", and add all your friends' addresses as POIs in the category. You can even add your friends' phone numbers with their address so you can call them from your GO.

For more information about POIs, see **Points of Interest** (38).

### Change car symbol

---

This button may only be available if all menu options are shown. To show all menu options, tap **Show ALL menu options**.

For more information, see **Hidden buttons and features** (49).

---

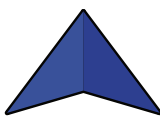

### Change car symbol

Tap this button to select a car symbol that will be used to show your current position in the Driving view.

## Change 2D/3D display / Turn on 2D display



**Turn on 2D display**

Tap **Turn on 2D display** to change the perspective for viewing the map.

For example, the 2D view shows a two dimensional view of the map as though viewed from above.



**Change 2D/3D display**

To switch the view to a three dimensional perspective, tap **Change 2D/3D display** and select a view from the list.

### When should I use this?

In some situations, it is easier to see the map from above. Perhaps if the road network is complicated or for times when you are walking while using your GO to navigate.

## Compass preferences

---

This button may only be available if all menu options are shown. To show all menu options, tap **Show ALL menu options**.

For more information, see **Hidden buttons and features** (49).

---



**Compass preferences**

Tap this button to configure the compass. The following options are available:

- **None** - the compass is not shown.
- **One with arrow pointing north** - the arrow always points towards north and the direction you are moving is shown at the top of the compass.
- **One with arrow showing your heading** - the arrow always shows the direction you are moving.

If you select one of these options, you then need to select the features that are shown in the middle of the arrow:

- **Direction** - your direction is shown as a compass point, displayed in the center of the compass arrow.
- **Degrees** - your direction is shown as compass degrees, displayed in the center of the compass arrow.
- **Nothing**
- **One with arrow pointing to your destination** - the arrow always points towards your destination. The distance to your destination is displayed in the compass arrow.

## Change map colors

---

This button may only be available if all menu options are shown. To show all menu options, tap **Show ALL menu options**.

For more information, see **Hidden buttons and features** (49).

---

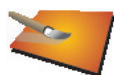

**Change map colors**

Tap this button to select the color schemes for day and night map colors.

You can also download more color schemes from TomTom PLUS.

## Brightness preferences

---

This button may only be available if all menu options are shown. To show all menu options, tap **Show ALL menu options**.

For more information, see **Hidden buttons and features** (49).

---



**Brightness preferences**

Tap this button to set the brightness of the screen.

You can set the brightness separately for day map colors and for night map colors.

You can also set these options:

- **Turn brightness down when dark** - your GO uses a light sensor to detect the background light level. If this option is selected, as it gets darker, your GO reduces the brightness of the screen so that it is not distracting.
- **Switch to night view when dark** - your GO uses a light sensor to detect the background light level. If this option is selected, when it gets dark, your GO uses night colors for the Driving View.

You can set the map color scheme by tapping **Change map colors**. For more information, see **Change map colors** (54).

## Status bar preferences

---

This button may only be available if all menu options are shown. To show all menu options, tap **Show ALL menu options**.

For more information, see **Hidden buttons and features** (49).

---



#### Status bar preferences

Tap this button to select the information shown on the status bar:

- **Remaining time** - the estimated time left until you reach your destination.
- **Remaining distance** - the distance left until you reach your destination.
- **Current time**
- **Arrival time** - your estimated arrival time.
- **Speed**
- **Direction**
- **Show next street name** - the name of the next street on your trip.
- **Show current street name**
- **Show leeway to arrival time** - your GO shows how late or early you will be compared with the preferred arrival time that is set during the planning of a route.
- **Show max speed next to speed** - only available when speed (above) is also selected.
- **How should the status bar be displayed?**

**Horizontal** - If you choose this option, the status bar will be shown at the bottom of the Driving view.

**Vertical** - If you choose this option, the status bar will be shown at the right-hand side of the Driving view.

---

**Note:** *If the speed limit for the road you are on is available, it is shown next to your speed.*

*If you drive faster than the speed limit, your speed is shown in red.*

---

## Automatic zooming

---

This button may only be available if all menu options are shown. To show all menu options, tap **Show ALL menu options**.

For more information, see **Hidden buttons and features** (49).

---



#### Automatic zooming

Tap this button to enable or disable automatic zooming in the Driving View.

## Quick menu preferences

---

This button may only be available if all menu options are shown. To show all menu options, tap **Show ALL menu options**.

For more information, see **Hidden buttons and features** (49).

---





### Quick menu preferences

Tap this button to choose up to six buttons to be used in the Quick menu.

The Quick menu button enables easy access for your most commonly used buttons.

The buttons you assign for use with the Quick menu, are shown in the Driving View.

## Guided tours

---

This button may only be available if all menu options are shown. To show all menu options, tap **Show ALL menu options**.

For more information, see **Hidden buttons and features (49)**.

---



### Guided tours

Tap this button to show one of the Guided tours on how to use your TomTom GO.

## Name preferences

---

This button may only be available if all menu options are shown. To show all menu options, tap **Show ALL menu options**.

For more information, see **Hidden buttons and features (49)**.

---



### Name preferences

Tap this button to set the information that is shown on the map in the Driving View. The following options are available:

- **Show house numbers before street names**
- **Show street names** - if you are using a computer voice for spoken instructions and have selected that street names should be read aloud, you do not need to select this option, since the street names will be read aloud even though this option is not selected.
- **Show next motorway / signpost** - when this option is selected, the next major road on your route is shown at the top of the screen in the Driving View.
- **Show current street name on map**

## Set units

---

This button may only be available if all menu options are shown. To show all menu options, tap **Show ALL menu options**.

For more information, see **Hidden buttons and features (49)**.

---



### Set units

Tap this button to set the type of units that will be shown for the following:

- Distance
- Time
- Latitude and longitude
- Temperature
- Air pressure

## Operate left-handed / Operate right-handed

---

This button may only be available if all menu options are shown. To show all menu options, tap **Show ALL menu options**.

For more information, see **Hidden buttons and features** (49).

---



### Operate left-handed

Tap this button to move important buttons, for example, the **Done** and **Cancel** buttons as well as the zoom bar, to the left hand side of the screen. This makes it easier to tap the buttons with your left hand without blocking the screen.

To move the buttons back to the right hand side of the screen, tap **Operate right-handed**.

## Keyboard preferences



### Keyboard preferences

You use the keyboard to enter your destination or to find an item in a list, such as a POI.

Tap this button to select the size of the keys on the keyboard and the keyboard layout. You can select from two sizes:

- **Large keyboard**
- **Small keyboard**

Three keyboard layouts are available:

- **ABCD keyboard**
- **QWERTY keyboard**
- **AZERTY keyboard**

---

**Note:** *The keyboard does not include accents of any kind for any language so you don't have to worry about entering letters with accents. Simply type the letter without the accent and your GO will recognize the word.*

---

## Planning preferences

---

This button may only be available if all menu options are shown. To show all menu options, tap **Show ALL menu options**.

For more information, see **Hidden buttons and features** (49).

---



### Planning preferences

Tap this button to set the kind of route planned when you select a destination.

The following options are available:

- **Ask me every time I plan**
- **Always plan fastest routes**
- **Always plan shortest routes**
- **Always avoid freeways**
- **Always plan walking routes**
- **Always plan bicycle routes**
- **Always plan for limited speed**

Then answer the following question:

**Do you want the route summary screen to close automatically after 10 seconds?**

## Toll road preferences

---

This button may only be available if all menu options are shown. To show all menu options, tap **Show ALL menu options**.

For more information, see **Hidden buttons and features** (49).

---



### Toll road preferences

Tap this button to set how your GO handles toll roads if they are on the route to a destination you set. You can choose from the following options:

- **Ask me when there are toll roads on my route** - you are asked if you want to avoid a toll road whenever you plan a route.
- **Always avoid toll roads**
- **Never to avoid toll roads**

## Set owner

---

This button may only be available if all menu options are shown. To show all menu options, tap **Show ALL menu options**.

For more information, see **Hidden buttons and features** (49).

---



### Set owner

Tap this button to enter your name and address as the owner of your GO and to change or delete a 4-digit password for your GO.

---

**Note:** You can only change or delete a 4-digit password on your TomTom GO.

---

You can create a 4-digit password for your GO using TomTom HOME:

1. Connect your GO to your computer and turn on your GO and your computer.

TomTom HOME starts automatically.

For information about installing TomTom HOME on your computer, see **Installing TomTom HOME** (89).

2. From the Options menu in TomTom HOME, click My GO.
3. Click the ON/OFF button on the picture of your GO to start the application on your computer.
4. From the Main Menu, click **Change preferences**.
5. Click **Set Owner**. You can now set a 4-digit password for your GO.

You can only create a 4-digit password using TomTom HOME.

## Speaker preferences

---

This button may only be available if all menu options are shown. To show all menu options, tap **Show ALL menu options**.

For more information, see **Hidden buttons and features** (49).

---



### Speaker preferences

Tap this button to select which speakers are used by your GO for playing music and spoken instructions.

For more information, see **Internal and external speakers** (17).

The following options are available:

- **Internal speaker**
- Bluetooth Hi-Fi device
- **Line-out (audio cable)**
- **FM to your car radio**

## Car preferences

---

This button may only be available if all menu options are shown. To show all menu options, tap **Show ALL menu options**.

For more information, see **Hidden buttons and features** (49).

---



Tap this button to change the way your GO responds to events in your car.

- **Link night view to headlights**
- **Instructions mute car radio**

## Music preferences

---

This button may only be available if all menu options are shown. To show all menu options, tap **Show ALL menu options**.

For more information, see **Hidden buttons and features (49)**.

---



Tap this button to change the way your GO behaves when playing music.

- **Shuffle songs**
- **Repeat songs**
- **Reduce brightness**
- **Show music button in Driving View**
- **Automatically switch to Driving View**
- **Slideshow**

## Start-up preferences

---

This button may only be available if all menu options are shown. To show all menu options, tap **Show ALL menu options**.

For more information, see **Hidden buttons and features (49)**.

---



Tap this button to select how your GO will behave when you turn on the device. The following options are available:

- **Continue where I left off** - your GO starts and shows the last screen that was shown when you turned off the device.
- **Ask for a destination** - your GO starts with **Navigate to...** menu. You can enter a destination immediately.
- **Show the Main Menu** - your GO starts with the Main Menu.
- **Start TomTom Jukebox** - your GO starts by opening the TomTom Jukebox.
- **Start Slideshow** - your GO starts by showing a slideshow of the images stored there. To interrupt the slideshow, tap the screen.

You are then asked if you want to change the picture that is shown whenever you start your GO.

Tap **No** to finish or tap **Yes** to see the photos stored on your GO and tap on a photo to select that photo for use as your start-up picture.

## Bluetooth preferences

---

This button may only be available if all menu options are shown. To show all menu options, tap **Show ALL menu options**.

For more information, see **Hidden buttons and features** (49).

---



Tap this button to disable or enable Bluetooth functionality on your GO.

Tap **Advanced** to set how the Bluetooth connection with your phone will be used.

You can select any of the following options:

- **Enable wireless data**
- **Enable hands-free calling**

In some places, such as hospitals and airplanes, you are required to turn Bluetooth off on all electronic devices.

## Disable wireless data / Enable wireless data

---

This button may only be available if all menu options are shown. To show all menu options, tap **Show ALL menu options**.

For more information, see **Hidden buttons and features** (49).

---



Tap this button to block the reception of wireless data. You will still be connected to your mobile phone via Bluetooth and will still be able to receive and make hands-free calls. You will not be able to receive any data that uses a wireless data connection, such as TomTom Traffic.

To turn wireless data on again, tap **Enable wireless data**.

## Send/Receive files

---

This button may only be available if all menu options are shown. To show all menu options, tap **Show ALL menu options**.

For more information, see **Hidden buttons and features** (49).

---



Tap this button to send or receive files, such as itineraries and voices, using your GO with other Bluetooth devices.

## Edit TomTom PLUS account

---

This button may only be available if all menu options are shown. To show all menu options, tap **Show ALL menu options**.

For more information, see **Hidden buttons and features** (49).

---



**Edit  
MyTomTom  
account**

Tap this button to log in to your TomTom account.

If you have more than one TomTom account or if several people are sharing the same TomTom GO, you can create another TomTom account using a different e-mail address.

## Battery saving preferences

---

This button may only be available if all menu options are shown. To show all menu options, tap **Show ALL menu options**.

For more information, see **Hidden buttons and features** (49).

---



**Battery saving  
preferences**

Tap this button to configure your GO to conserve power when possible. The following options are available:

- **Never turn off screen**
- **Turn off screen between instructions**
- **Always turn off screen**

Then select whether or not you want to **Switch off when external power is lost**.

## Change language



**Change  
language**

Tap this button to change the language used for all the buttons and messages you see on your GO.

You can choose from a wide range of languages. When you change the language, you are also given the opportunity to change the voice.

## Set clock



**Set clock**

Tap this button to select the type of clock that is shown and set the time.

The easiest way to set the time is by tapping the **Sync** button. Your GO will then take the time from GPS information.

For more information about GPS, see **Global Positioning System (GPS)** (88).

---

**Note:** After using **Sync** to set the time, you may have to adjust the hours depending on your time zone. Your GO works out your time zone and always keeps the time correct using GPS information.

You can only use **Sync** if you have GPS reception, so you cannot set the clock in this way when you are indoors.

---

## Hidden buttons and features

When you first start using your TomTom GO, all the buttons are shown in the menu.

The buttons for the more advanced features can be hidden. This is a useful option because you are unlikely to use certain features very often.



#### Show fewer menu options

Tap this button in the Preferences menu, to reduce the number of buttons that are shown.

You might want to do this so that only frequently used buttons are shown.

When you need to use the buttons that are hidden, you can press **Show ALL menu options** in the Preferences menu to show all buttons.



#### Show ALL menu options

Tap this button in the Preferences menu, to show all the buttons available on your TomTom GO.

### Hide tips / Show tips

---

This button may only be available if all menu options are shown. To show all menu options, tap **Show ALL menu options**.

For more information, see **Hidden buttons and features** (49).

---



#### Hide tips

Tap this button to stop your GO from showing tips.

To turn tips on again, tap **Show tips**.

### Reset factory settings

---

This button may only be available if all menu options are shown. To show all menu options, tap **Show ALL menu options**.

For more information, see **Hidden buttons and features** (49).

---



#### Reset factory settings

Tap this button to restore the factory settings to your TomTom GO.

All your settings, including Favorites, your Home location, warnings for POIs and any Itineraries you have created, as well as recent destinations and recent calls and callers, will be deleted.



## 17. TomTom PLUS

---

TomTom Services keep you informed and entertained while you're on the road.

You can subscribe to a range of extras and download them either directly to your GO or to your computer and then transfer them to your GO.

---

### Tips

- New services are being added regularly. Use TomTom HOME or visit [www.tomtom.com/plus](http://www.tomtom.com/plus) to find out what's available.
- To download TomTom PLUS services to your GO, you need a mobile phone with Bluetooth and a wireless data connection (GPRS, EDGE, UMTS or CDMA). Your mobile phone company may charge you for using a wireless data connection.

Don't forget that you can download many TomTom PLUS services to your computer without needing to set up a wireless data connection.

- Not all services are available in all countries. For more information, visit [www.tomtom.com/plus](http://www.tomtom.com/plus)
- 



#### Traffic

Get the fastest and most reliable updates from local sources.



#### Radar cameras

Be smart and stick to the speed limit.



#### Maps

Download detailed maps of many cities throughout the world or even whole countries.



#### Voices

Get instructions from John Cleese and many other funny voices.



#### Buddies

Instant messaging and navigation meet on your GO.



#### Audiobooks

Let famous narrators read you the latest best sellers.



### **Weather**

Get weather forecasts for the next 5 days or check the current weather at your destination.



### **Points of Interest**

Find the places you need quickly with the locations of thousands of Points of Interest (POIs).

## 18. TomTom Map Share

---

TomTom Map Share™ is a free technology that lets you make updates to your map and if you want to, share those updates with other members of the TomTom Map Share community.

If you find a street that has recently been blocked to traffic which was open before, you can use Map Share to update your map and then share the update with other Map Share members.

You can use Map Share to send and receive map updates during the first year after the map's release date. This means that one year after the release date, you will no longer be able to send or receive map updates for that version of the map - You will still be able to make updates to your own map for use on your own device.

When you join the TomTom Map Share community you can keep your maps up-to-date with the latest updates made by other Map Share community members.

You choose the type of updates you want and each time you connect your TomTom GO to TomTom HOME, the map is automatically updated.

### TomTom Map Share community

To join the Map Share community, do the following:

1. Tap **Map corrections** in the Main Menu.

---

**Tip:** If you cannot see the **Map corrections** button in the Main Menu, tap **Show ALL menu options** in the Preferences menu.

---

2. Tap **Download corrections made by others**.
3. Tap **Join**.

When you connect your TomTom GO to computer, TomTom HOME automatically downloads any available map updates and sends any changes you have made, to the Map Share community.

### Map updates

There are two types of map update:

- Updates that are immediately shown on the map. These include, changing the traffic flow of a street, blocking or renaming a street and adding or editing POIs.

This type of change is immediately shown on your own map. You can hide these updates at any time in the Map Share preferences menu.

For more information on showing and hiding updates, see **Changing my preferences for map updates** (69).

- Updates that are reported to TomTom but not shown immediately on your map. These include, missing streets, errors in freeway entrances and exits and missing roundabouts.

This type of update is investigated by TomTom and once verified, is included in the next map release. These updates are therefore not shared with the Map Share community.

---

**Tip:** If you cannot see the **Map corrections** button in the Main Menu, tap **Show ALL menu options** in the Preferences menu.

---

## Making a map update



1. Tap **Map corrections** in the Main Menu.
2. Tap **Correct a map error**.  
A list of possible map updates is shown.
3. Select the type of update you want to report.

---

**Note:** If you tap **Add missing POI** or **Report other error** you will be asked for some additional information before the next step.

---

4. Select the method you want to use for selecting the location of the update.
5. When you have found the location, tap **Done**.
6. Enter update or confirmation of update now.

For more information on the different types of updates you can make, see **Map update categories** (69).

## Marking a map error while on the move

If you notice an item on your map that needs attention, you can mark the location using the **Report** button and then enter the details when you are no longer driving.

To show the **Report** button in the Driving View, do the following:

1. Tap **Map corrections** in the Main Menu.

---

**Tip:** If you cannot see the **Map corrections** button in the Main Menu, tap **Show ALL menu options** in the Preferences menu.

---

2. Tap **Correction preferences**.
3. Tap **Done** and then tap **Done** again.
4. Select **Show report button**, then tap **Done**.

The **Report** button is shown on the left-hand side of the Driving View. After you mark a location, you can add more information about the change when you open the **Map corrections** menu.

For example, you are driving to a friend's house and you notice that the name of the street you are on is different from the one on your map. To report the

change, tap the **Report** button and your GO will save your current location. You can then send the update to TomTom Map Share when you have finished your journey.

---

For more information see **Changing my preferences for map updates** (69).

---

## Receiving the latest map updates

When you connect your TomTom GO to your computer, TomTom HOME automatically downloads any available map updates and sends any changes you have made, to the Map Share community.

There are several types of updates which can be set in the Correction preferences menu.

For information about how to do this, see **Changing my preferences for map updates** (69).

## Changing my preferences for map updates

Correction preferences is used to set the way TomTom Map Share runs on your device.

You can set the following preferences:

- Choose what types of updates you want to use on your maps.
- Decide if you want to share your updates with others.
- Show or hide the **Report** button in the Driving View.

To set your preferences, do the following:

1. Tap **Map corrections** in the Main Menu.
2. Tap **Correction preferences**.  
A list of update types is shown.
3. Tick the box next to each update type you want use.
4. Tap **Done**.
5. Choose how you want to share your map updates with the Map Share community, then tap **Done**.
6. Choose if you want to see the **Report** button in the Driving View.
7. Tap **Done**.

---

**Tip:** If you later decide you want to remove updates from the map, clear the checkbox next to the types of update you want to remove. If you clear all the checkboxes, your map returns to the original state before the first update.

---

For more information on how to use the **Report** button, see **Marking a map error while on the move** (68).

## Map update categories

There are several types of update that you can make to a map.

To make an update to your map, tap **Map corrections** in the Main Menu then tap **Correct a map error**. The following types of updates are shown.

---



**(Un)block street**

Tap this button to block or unblock a street. You can block or unblock the street in one or both directions.

For example, to correct a street near to your current location, do the following:

1. Tap **(Un)block street**.
2. Tap **Near you** to select a street near your current location. You can select a street by name, a street near your Home location or a street on the map.
3. Select the street or section of a street you want to correct by tapping it on the map.

The street you select is highlighted and the cursor shows the name of the street.

4. Tap **Done**.

Your device shows the street and whether the traffic is blocked or allowed in each direction:

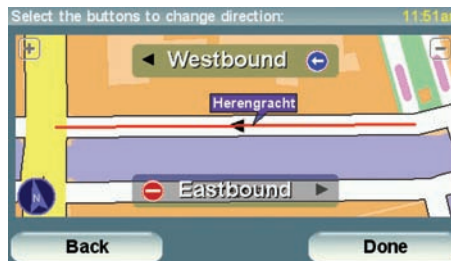

5. Tap one of the direction buttons to block or unblock the flow of traffic in that direction.
6. Tap **Done**.

The next time you connect your device to TomTom HOME, your updates are shared with the TomTom Map Share community.

---



**Reverse traffic direction**

Tap this button to correct the traffic direction of a one-way street, where the direction of traffic is different to the direction shown on your map.

---

**Note:** Reverse traffic direction only works for one-way streets. If you select a two-way street you will be given the chance to block/unblock the street rather than changing the direction.

---



### Edit street name

Tap this button to change the name of a street on your map.

For example, to rename a street near to your current location:

1. Tap **Edit street name**.
2. Tap **Near you**.
3. Select the street or section of a street you want to correct by tapping it on the map.

The street you select is highlighted and the cursor shows the name of the street.

4. Tap **Done**.
5. Type the correct street name.
6. Tap **Done**.



### Add missing POI

Tap this button to add a new Point of Interest (POI).

For example to add a new restaurant near to your current location:

1. Tap **Add missing POI**.
2. Tap **Restaurant** in the list of POI categories.
3. Tap **Near you**.
4. Select the location of the missing restaurant.

You can select the location by entering the address or by selecting the location on the map. Select **Near you** or **Near home** to open the map at your current location or at your Home location.

5. Tap **Done**.
6. Type the name of the restaurant then tap **OK**.
7. If you know the telephone number of the restaurant you can type it, then tap **OK**.

If you don't know the number, just tap **OK** without typing a number.



### Edit POI

Tap this button to edit an existing POI.

You can use this button to make the following changes to a POI:

- Delete the POI.
- Rename the POI.
- Change the telephone number of the POI.
- Change the category that a POI belongs to.
- Move the POI on the map.



### Report other error

Tap this button to report other types of update.

These updates are not immediately corrected on your map. Your TomTom GO sends a special update report to TomTom Map Share.

You can report missing streets, errors in freeway entrances and exits and missing roundabouts. If the update you want to report is not covered by any of these report types, enter a general description then tap **Other**.

---

## 19. Traffic information

---

You can obtain traffic information in two ways:

- TomTom Traffic
- Traffic Message Channel (TMC)

---

**Important:** Reliable TMC Traffic reception is highly dependent upon optimal antenna placement, vehicle features such as windshield reflective shielding, the surrounding environment such as mountains and high buildings and RDS-TMC Radio station transmission signal strength.

Some vehicles have a heat reflective shield embedded in the windshield which might prevent a navigation device from locating your current position. If this is a problem in your vehicle, use the TomTom External Antenna Kit (available as an accessory).

---

### TomTom Traffic

TomTom Traffic is a TomTom Service for receiving up-to-date traffic information from the best local sources.

To use TomTom Traffic, you will need to establish a wireless data connection (GPRS, EDGE, UMTS, CDMA) between your TomTom device and a Bluetooth enabled mobile phone and you must have a wireless data subscription with your mobile network operator.

For more information, see **TomTom Traffic (73)**.

### The Traffic Message Channel (TMC)

TMC transmits traffic information as a radio signal and is available free-of-charge in many countries.

TMC is not a TomTom Service, but is available when using the TomTom RDS-TMC Traffic Receiver. The TomTom RDS-TMC Traffic Receiver is included with some products and available as an accessory for others.

---

**Note:** *TomTom is not responsible for the availability or quality of traffic information provided by TMC.*

*TMC is not available in all countries or regions. Visit [www.tomtom.com/plus](http://www.tomtom.com/plus) to check for availability in your country or region.*

---

For more information, see **Traffic information using RDS-TMC (80)**.



## 20. TomTom Traffic

---

TomTom Traffic is a TomTom Service for receiving up-to-date traffic information. TomTom Traffic requires a Bluetooth-enabled mobile phone and a wireless data connection (GPRS, EDGE, UMTS, CDMA).

TomTom Traffic uses the most up-to-date information from the best local sources. For more information about subscribing see [www/tomtom.com/plus](http://www.tomtom.com/plus).

### Setting up TomTom Traffic

To use TomTom Traffic, you need to establish a connection between your mobile phone and your TomTom device. If you have not already done so, tap **Mobile phone** in the **Main Menu** to establish this connection and then do the following:

1. Tap TomTom **Traffic** in the Main Menu.
2. Tap **Enable Traffic**.

---

***Note:** TomTom Traffic retrieves traffic information using a wireless data connection on your mobile phone. You must establish a Bluetooth connection between your phone and your device and you must also have a wireless data subscription with your mobile network operator.*

---

3. Enter your username and password.

The Traffic sidebar is shown on the right-hand side of the Driving View and your device retrieves the latest traffic information from TomTom.



The following symbols are shown at the top of the Traffic sidebar:



Your device is busy retrieving traffic information.



Traffic information is up to date.

---



Traffic information has not been updated for at least 15 minutes.



Traffic information has not been updated for at least 30 minutes.



Traffic information has not been updated for at least 45 minutes.



Traffic information has not been updated for at least one hour.



No connection is available between your TomTom device and your mobile.

---

**Tip:** Providing you have a connection between your device and mobile phone, You can retrieve the latest traffic information straight away by tapping the **Update traffic info** button in the Traffic menu.

---

## Using TomTom Traffic



If you have a route planned on your device and there are any incidents on that route, the Traffic sidebar on the right side of the Driving View warns you. An example of a Traffic sidebar with a traffic warning is shown on the left. For information on the Traffic sidebar, see **The Traffic sidebar** (75).

In the example on the left there is a traffic jam on your route that will cause an expected delay of 38 minutes, 20 miles ahead of you. To find the quickest route to your destination, do the following:

1. Tap the Traffic sidebar.

---

**Tip:** If you have trouble tapping the Traffic sidebar and the Main Menu is being displayed instead of the traffic menu, try tapping your finger half on the Traffic sidebar and half off the screen.

---

2. Tap **Minimize traffic delays**.

Your device looks for the quickest route to your destination.

It is possible that the new route may also include traffic delays, or may even be the same route as before. You can re-plan the route to avoid all delays, but this new route will take longer than the quickest route already shown.

3. Tap **Done**.

---

**Tip:** You can let your TomTom device automatically minimise traffic delays for you. To do this, see **Changing traffic preferences** (75).

---

## Changing traffic preferences

Use the **Change Traffic preferences** button to choose how traffic information works on your device.



To change your traffic preferences, do the following:

1. Tap the TomTom**Traffic** button in the Main Menu on your device.
2. Tap **Change Traffic preferences**.

You can change the following preferences:

- **Automatically minimise delays after every traffic update** - if you select this option, your device automatically recalculates your route when new delays occur on your route.
  - **Automatically update traffic info while on route** - if you select this option, your device automatically updates traffic information whenever you have a route planned.
  - **Beep when traffic situation on route changes** - if you select this option your device beeps when a new traffic incident occurs on your current route.
  - **Ask for traffic updates when preparing a route** - if you select this option, your device asks if you want to update traffic information before looking for any delays on routes that you plan.
3. Select or clear the check box next to each preference you want to change.
  4. Tap **Done**.
  5. If you chose to automatically update traffic information while on route (one of the options shown above), you are asked if you want to limit how often that information is updated.  
  
Tap **No** to use the default interval of 4 minutes.  
  
Tap **Yes** if you want to change the frequency of your automatic traffic updates.
  6. Tap **Done**.

## The Traffic sidebar

The Traffic sidebar shows you the traffic incidents on your route. It shows the following information:

- A symbol for each traffic incident in the order they occur along your planned route.
- The estimated delay of the next traffic incident on your route.
- The distance from your current location to the first incident on the Traffic sidebar.

An example of a Traffic sidebar is shown below.



In the example, the Traffic sidebar shows you that there are two incidents ahead. Both incidents are traffic jams, the first is 15 miles ahead and is expected to delay you by at least 51 minutes.

To re-plan your route to avoid these incidents, tap the Traffic sidebar to open the TomTom **traffic** menu, then tap **Minimise traffic delays**. For more information see **Using TomTom Traffic (74)**.

## Making commuting to work easier

The **Home to work** or **Work to home** buttons in the Traffic menu lets you check your route to and from work with one tap of a button. When you use either of these buttons, your device checks the route for possible delays, and if it finds any, provides you with the possibility to avoid them.

The first time you use **Home to work**, you must set your traffic home and work locations, do the following:



1. Tap the TomTom**Traffic** button in the Main Menu on your device.
2. Tap **Show home-work traffic**.
3. Tap **Change home-work**
4. Set your home location
5. Set your work location.

You can now use the **Home to work** and **Work to home** buttons of the Show home-work traffic menu.

---

**Note:** *The home location you set here is not the same as the home location you can set in the **Preferences Menu**. In addition, the locations you use here do not have to be your actual home and work locations. If there is another route that you often travel, you can set Work/Home to use these locations instead.*

---

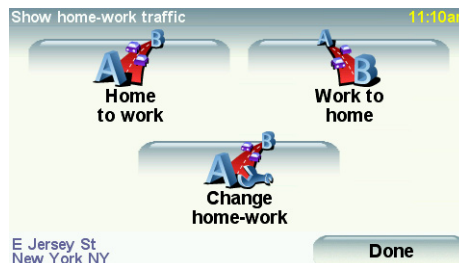

For example, to check for delays on your route home, do the following:

1. Tap the TomTom**Traffic** button in the Main Menu on your device.
2. Tap **Show home-work traffic**.
3. Tap **Work to home**.

The route summary screen is shown. In this example, you can see that there are some traffic incidents on your route that could mean a delay of up to 25 minutes.



To see if there is a quicker way home, you could now tap the **Find alternative** button and then tap **Minimize traffic delays**.

---

**Tip:** You can let your device automatically look for alternative routes by selecting **Automatically minimize delays after every traffic update** in your Traffic preferences. For more information, see **Changing traffic preferences (75)**.

---



---

**Note:** *It is possible that the alternative route could be longer than your original one (even with its delays). If this is the case, you could always try using the **Find alternative** button again.*

---

## Checking traffic incidents in your area



**Browse map**

Get an overview of the traffic situation in your area, using the map. To find local incidents and their details, do the following:

1. Tap the TomTom**Traffic** button in the Main Menu on your device.
2. Tap **Browse map**.  
The map browser screen is shown.
3. Tap the blue compass image in the top right of the screen.

The map centers itself on your current location, and any traffic incidents in the area are shown as small symbols. These symbols are described in, **Traffic incidents (77)**.

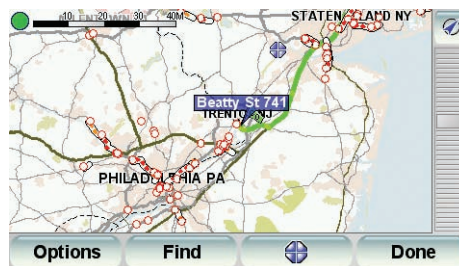

4. Tap on any traffic incident to get more information.

A second screen is shown that gives you detailed information about the incident you chose. To display information about surrounding incidents use the left and right arrows at the bottom of this second screen.

## Traffic incidents

Traffic incidents are displayed both on the Driving View and also on the Traffic sidebar as small symbols. There are two type of symbols:

- Symbols shown in a red square are incidents that Traffic can help you avoid.

- Symbols shown in a red rectangle are weather related, because of their nature, you cannot use Traffic to avoid them.

Traffic incident symbols and their meaning are shown below:



**Accident**



**Road closed**



**Road works**



**Traffic incident**



**One or more lanes closed**



**Traffic jam**

Weather related symbols and their meaning are shown below:



**Fog**



**Ice**



**Rain**



**Snow**



**Wind**



**Note:** The incident avoided symbol is shown for any traffic incident that you avoid using TomTom **Traffic**.

## Traffic menu

Either, tap the Traffic sidebar in the Driving View or tap TomTom **Traffic** in the Main Menu to open the Traffic menu. The following buttons are available:



**Minimize traffic delays**

Tap this button to re-plan your route based on the latest traffic information.



**Show traffic on route**

Tap this button to see an overview of all traffic incidents on your route. You can use the left and right buttons on the resulting screen to see more detailed information about each of these incidents.



**Show home-work traffic**

Tap this button to calculate and show the quickest route from your home location to your place of work and back.

See **Making commuting to work easier** (76).



**Read aloud traffic info**

Tap this button to read aloud all traffic incidents along your route.



**Update traffic info**

Tap this button to get the latest traffic information straight away rather than waiting for an automatic update.

For more information on automatic traffic updates, see **Changing traffic preferences (75)**.



**Disable Traffic**

Tap this button to disable TomTom **Traffic**.



**Help**

Tap this button to view the guided tour on how to use TomTom **Traffic**.



**Browse map**

Tap this button to browse the map and see the traffic information displayed on the map.

See **Checking traffic incidents in your area (77)**.



**Change Traffic preferences**

Tap this button to change your preferences for how TomTom **Traffic** works on your device.

See **Changing traffic preferences (75)**.

---

## 21. Traffic information using RDS-TMC

---

### The Traffic Message Channel (TMC)

The Traffic Message Channel (TMC) is not a TomTom Service. FM radio stations in several countries broadcast TMC information as part of their programming. TMC is also known as RDS-TMC traffic information.

Your TomTom device uses this information to warn you about traffic delays along your route and how you can avoid them.

To use TMC traffic information, you need a TomTom RDS-TMC Traffic Receiver that comes with some TomTom devices or is available as an accessory for others. For more information on which TomTom devices support RDS-TMC receivers, visit [www.tomtom.com](http://www.tomtom.com).

---

**Note:** TomTom is not responsible for the availability or quality of traffic information provided by TMC.

TMC is not available in all countries or regions. Visit [www.tomtom.com](http://www.tomtom.com) to check if it is available in your country or region.

---

### Setting up TMC

To start using TMC, all you need to do is connect the RDS-TMC Traffic Receiver to your TomTom device or to the windscreen mount of your TomTom device, depending on your product.

The receiver works best when mounted in a vertical position, so if possible, try to place your TomTom device towards the drivers side corner of the windscreen so that the receiver can be secured out side of your field of vision.

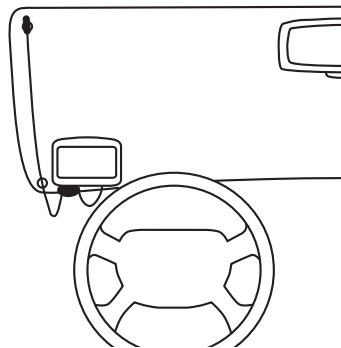

After you have finished positioning the receiver switch your TomTom device on. The Traffic sidebar is shown on the right-hand side of the Driving View and your device searches for a radio station that has RDS-TMC information.





The following symbols are shown at the top of the Traffic sidebar:



Your device is looking for a radio station with RDS-TMC traffic information.



Your device has found a suitable radio station and is checking for the latest traffic information.



Your device is tuned to a radio station and receives RDS-TMC traffic information when available.

---

**Tip:** The yellow circle is shown at the top of the Traffic sidebar if your device cannot find a suitable radio station. You can make your device try again to find a suitable station by tapping **Tune automatically** in the traffic menu. If you know the FM frequency of a station that broadcasts RDS-TMC traffic information, you can tune to it manually. For more information see **Setting the radio frequency for RDS-TMC information** (84).

---

## Using RDS-TMC traffic information



Your device receives traffic information when it is broadcasted.

If there are any incidents on your route the Traffic sidebar on the right side of the Driving View warns you. An example of a Traffic sidebar with a traffic warning is shown to the left. For information on the Traffic sidebar, see **The Traffic sidebar** (85).

In the example on the left there is a traffic jam on your route with an expected delay of 38 minutes, 20 miles ahead of you. To find the quickest route to your destination, do the following:

1. Tap the Traffic sidebar.

---

**Tip:** If you have trouble tapping the Traffic sidebar and the Main Menu is being displayed instead of the traffic menu, try tapping your finger half on the Traffic sidebar and half off the screen.

---

2. Tap **Minimize traffic delays**.

Your device looks for the quickest route to your destination.

It is possible that the new route may also include traffic delays, or may even be the same route as before. You can re-plan the route to avoid all delays, but this new route will take longer than the quickest route already shown.

3. Tap **Done**.

---

**Tip:** It is possible to let your TomTom device automatically minimize traffic delays for you, to do this, see **Changing traffic preferences** (82).

---

## Changing traffic preferences

Use the **Change Traffic preferences** button to choose how traffic information works on your device.



**Change  
Traffic  
preferences**

To change your traffic preferences, do the following:

1. Tap the TomTom**Traffic** button in the Main Menu on your device.
2. Tap **Change Traffic preferences**.

You can change the following preferences:

- **Automatically minimize delays after every traffic update** - if you select this option, your device automatically recalculates when new delays occur on your route.
- **Beep when traffic situation on route changes** - if you select this option your device beeps when a new traffic incident occurs on your current route.
- **Ask for traffic updates when preparing a route** - this option has no effect in RDS traffic.

3. Select or clear the check box next to each preference you want to change.

4. Tap **Done**.

Your device lists the countries that have radio stations providing RDS-TMC traffic information that you can currently receive. Normally you can leave this set to **Any country (strongest signal)**. For more information about this country setting, see **Choosing the correct country for RDS-TMC reception** (84).

5. Tap **Done**.

## Making commuting to work easier

The **Home to work** or **Work to home** buttons in the Traffic menu lets you check your route to and from work with one tap of a button. When you use either of these buttons, your device checks the route for possible delays, and if it finds any, provides you with the possibility to avoid them.

The first time you use **Home to work**, you must set your traffic home and work locations, do the following:

1. Tap the TomTom**Traffic** button in the Main Menu on your device.
2. Tap **Show home-work traffic**.
3. Tap **Change home-work**
4. Set your home location
5. Set your work location.



You can now use the **Home to work** and **Work to home** buttons of the Show home-work traffic menu.



For example, to check for delays on your route home, do the following:

1. Tap the TomTom**Traffic** button in the Main Menu on your device.
2. Tap **Show home-work traffic**.
3. Tap **Work to home**.

The route summary screen is shown.

To see if there is a quicker way home, you could now tap the **Find alternative** button and then tap **Minimize traffic delays**.

---

**Tip:** You can let your device automatically look for alternative routes by selecting **Automatically minimize delays after every traffic update** in your Traffic preferences. For more information, see **Changing traffic preferences** (82).

---

---

**Note:** *It is possible that the alternative route could be longer than your original one (even with its delays). If this is the case, you could always try using the **Find alternative** button again.*

---

## Checking traffic incidents in your area



**Browse map**

Get an overview of the traffic situation in your area, using the map. To find local incidents and their details, do the following:

1. Tap the TomTom**Traffic** button in the Main Menu on your device.
2. Tap **Browse map**.
3. Tap the blue compass image in the top right of the screen.

The map browser screen is shown.

The map centers itself on your current location, and any traffic incidents in the area are shown as small symbols. These symbols are described in, **Traffic incidents** (85).

4. Tap on any traffic incident to get more information.

A second screen is shown that gives you detailed information about the incident you chose. To display information about surrounding incidents use the left and right arrows at the bottom of this second screen.

## Setting the radio frequency for RDS-TMC information



**Tune manually**

If you know the frequency of a particular radio station you want to use for RDS-TMC traffic information, do the following to set the frequency manually:

1. Tap the Traffic sidebar in the Driving View.
2. Tap **Tune Manually**.
3. Enter the frequency of the radio station.
4. Tap **Done**.

Your TomTom device looks for your radio station. If it doesn't find a radio station at the frequency you set, it automatically continues to search for the next available station.

## Choosing the correct country for RDS-TMC reception

If you are driving close to a country border, your device may tune to a radio station from a neighboring country. If this happens you will only receive RDS-TMC traffic information for that country. To set the country you want to receive traffic information for, do the following:

1. Tap the Traffic sidebar in the Driving View.
2. Tap **Change Traffic preferences**.

A list of preferences you can choose is shown, these preferences are described in **Changing traffic preferences** (82).

3. Tap **Done**.

A list of neighboring countries is shown.

4. Tap on the country that you want to receive traffic reports for.

Your TomTom device then searches for a radio station in the country you have chosen.

## The Traffic sidebar

The Traffic sidebar is shown on the right side of the Driving View when TomTom **Traffic** is switched on. The Traffic sidebar shows you the traffic incidents on your route. It shows the following information:

- A symbol for each traffic incident in the order they occur along your planned route.
- The estimated delay to the next traffic incident on your route.
- The distance from your current location to the next incident on your route.

An example of a Traffic sidebar is shown below.



In the example, the Traffic sidebar shows you that there are two incidents ahead. Both incidents are traffic jams, the first is 15 miles ahead and is expected to delay you by at least 51 minutes.

To re-plan your route to avoid these incidents, tap the Traffic sidebar to open the TomTom **traffic** menu, then use **Minimize traffic delays**. For more information see **Using RDS-TMC traffic information (82)**.

## Traffic incidents

Traffic incidents are displayed both on the Driving View and also on the Traffic sidebar as small symbols. There are two type of symbols:

- Symbols shown in a red square are incidents that Traffic can help you avoid.
- Symbols shown in a red rectangle are weather related, because of their nature, you cannot use Traffic to avoid them.

Traffic incident symbols and their meaning are shown below:



Accident



Road closed



Road works



Traffic incident



One or more lanes closed



Traffic jam

Weather related symbols and their meaning are shown below:



Fog



Ice



Rain



Snow



---

**Note:** The incident avoided symbol is shown for any traffic incident that you avoid using TomTom **Traffic**.

---

## Traffic menu

Tap the Traffic sidebar in the Driving View to open the Traffic menu. The following buttons are available:



**Minimize traffic delays**

Tap this button to re-plan your route based on the latest traffic information.



**Tune automatically**

Tap this button to get your device to automatically search for a radio frequency that carries RDS-TMC traffic information.

---

**Note:** Your TomTom device automatically searches for a suitable radio station, use this button to force your device to search for the next suitable station.

---



**Tune manually**

Tap this button to get your device to tune to a specific radio frequency that carries RDS-TMC traffic information.

See **Setting the radio frequency for RDS-TMC information** (84).



**Show traffic on route**

Tap this button to show areas of traffic congestion along your current route.



**Read aloud traffic info**

Tap this button to read aloud all traffic incidents along your route.



**Disable Traffic**

Tap this button to disable TomTom **Traffic**.



**Browse map**

Tap this button to browse the map and see the traffic information displayed on the map.

See **Checking traffic incidents in your area** (84).

---



**Show home-work traffic**

Tap this button to calculate and show the quickest route from your home location to your place of work and back.

See **Making commuting to work easier** (83).

---



**Help**

Tap this button to view the guided tour on how to use TomTom **Traffic**.

---



**Change Traffic preferences**

Tap this button to change your preferences for how TomTom **Traffic** works on your device.

See **Changing traffic preferences** (82).

---

## 22. How Does Navigation Work?

---

### Global Positioning System (GPS)

In order to navigate you to your destination, your TomTom GO must know where you are now. To find your current position, your GO uses the Global Positioning System (GPS). GPS is available for free and without subscription.

GPS uses satellites to transmit signals to GPS receivers. Your TomTom GO has a built-in GPS receiver. Using the GPS signal, your GO can work out where you are and how fast you are going. GPS signals work in all weather, anywhere in the world.

---

**Note:** *Your TomTom GO does not transmit your position, so others cannot use it to track you while you are driving. You can however send your position to TomTom Buddies. For more information, visit [www.TomTom.com/plus](http://www.TomTom.com/plus)*

---

### Finding your position faster

If you use your TomTom GO in combination with TomTom HOME, your GO will download information about where the GPS satellites are going to be for the next 7 days.

With this information, your GO will be able to find your current position very quickly when it is first switched on.

### Maps

Once your TomTom GO knows where you are and you have told it where you want to go, it uses the digital map on the memory card or hard disk to work out the best route to your destination.



## 23. Using TomTom HOME

---

TomTom HOME is a free software program for your computer that enables you to:

- Manage maps, voices, POIs and more.
- Transfer music and photos to your TomTom.
- Buy TomTom services and manage your subscriptions.
- Update your TomTom with the latest software and services automatically.
- Make and restore backups.
- Set a password to restrict access.
- Read the full version of the user manual.

### Installing TomTom HOME

There are two ways to install TomTom HOME on your computer.

Internet installation:

- Connect the Home Dock to your computer using the USB cable.
- Place your TomTom in the Home Dock and connect your computer to the Internet. The installation will start automatically.

CD installation:

- Place the CD that came with your TomTom into your computer and follow the instructions.

If the installation does not automatically start, after you insert the CD, browse to the CD on your computer and double-click the file named **Install TomTom HOME**.

Once installed, TomTom HOME will start automatically as soon as you connect your TomTom to your computer.

### HOME Help Topics

In the TomTom HOME Help topics you can find all kinds of tips and tricks on how to use TomTom HOME.

### MyTomTom Account

In order to buy content and services through TomTom HOME you will have to set up a MyTomTom account for the device you want to buy the content for. You will be asked to create an account when you start using TomTom HOME.

## 24. TomTom Limited Warranty

---

### WARRANTOR

U.S. and Canadian Purchases: If you have made your purchase in the United States or Canada, this Limited Warranty is granted by and this Limitation of Liability is stipulated for the benefit of TomTom Inc., 150 Baker Avenue Extension, Concord Massachusetts 01742 (United States of America).

### WHAT THIS WARRANTY COVERS

1) TomTom Inc. ("TomTom") warrants to the original purchaser ("you") of the hardware with which this Limited Warranty is included ("Hardware") that the Hardware will be free from defects in workmanship and materials under normal use ("Defects") for a period of one (1) year from the date that the Hardware was first purchased by you ("Warranty Period"). During the Warranty Period the Hardware will be repaired or replaced at TomTom's choice ("Limited Warranty") without charge to you for either parts or labour. This Limited Warranty covers the replacement of the Hardware only. If the Hardware is repaired after the Warranty Period has expired, the Warranty Period for the repair will expire six (6) months after the date of repair.

### WHAT THIS WARRANTY DOES NOT COVER

2) The Limited Warranty does not apply to normal wear and tear, does not apply when the Hardware is opened or repaired by someone not authorized by TomTom and does not cover repair or replacement of any Hardware or part thereof damaged by: misuse, moisture, liquids, proximity or exposure to heat and accident, abuse, non-compliance with the instructions supplied with the Hardware, neglect or misapplication. The Limited Warranty does not cover physical damage to the surface of the Hardware. This Limited Warranty does not cover any software that may accompany or be installed on the Hardware. The Limited Warranty does not cover the installation, removal or maintenance of the Hardware or any costs related herewith.

### HOW TO MAKE A WARRANTY CLAIM

3) In order to make a claim of a Defect, you must contact TomTom during the Warranty Period at: 1-978-287-9555 or per email via [www.tomtom.com](http://www.tomtom.com) to explain the Defect and to obtain an RMA number (Return Materials Authorization) if necessary. You must return the Hardware during the Warranty Period, along with an explanation of the Defect, to the address provided to you by TomTom. If a defect arises and a valid claim under this Limited Warranty is received by TomTom after the first one hundred and eighty (180) days of the Warranty Period, TomTom is entitled to charge you for any reasonable shipping and handling costs made in connection with the repair or replacement of the Hardware. You must comply with any other return procedures stipulated by TomTom, if any.

## YOUR LEGAL RIGHTS

- 4) This Limited Warranty gives you specific legal rights, and you may also have other rights which vary from state to state and jurisdiction to jurisdiction.
- 5) If any part of this Limited Warranty is held to be invalid or unenforceable, the remainder of the Limited Warranty shall nonetheless remain in full force and effect.
- 6) This Limited Warranty is the only express warranty made to you and is provided in lieu of any other express warranties or similar obligations (if any) created by any advertising, documentation, packaging, or other communications.
- 7) Except for the Limited Warranty and to the maximum extent permitted by applicable law, TomTom and its suppliers provide the Hardware "AS IS AND WITH ALL FAULTS", and hereby disclaim all other warranties and conditions, whether express, implied or statutory, including, but not limited to, any (if any) implied warranties, duties or conditions of: merchantability, non-infringement, quiet enjoyment, system integration, satisfactory quality, fitness for a particular purpose, reliability or availability, accuracy or completeness of responses, results, workmanlike effort, lack of viruses, and reasonable care and skill, all with regard to the Hardware, and the provision of or failure to provide support or other services, information, software, and related content through the Hardware or otherwise arising out of the use of the Hardware. This exclusion does not apply to (i) any implied condition as to title and (ii) any implied warranty as to conformity with description. If applicable law requires any implied warranties with respect to the Hardware, all such warranties are limited in duration to ninety (90) days. Some states and/or jurisdictions do not allow limitations on how long an implied warranty lasts, so the above may not apply to you.
- 8) This Limited Warranty cannot be transferred to any other person.

## LIMITATION OF LIABILITY

- 9) Neither TomTom nor its suppliers shall be liable to you or to any third party for any indirect, incidental, consequential, special or exemplary damages (including in each case, but not limited to, damages for the inability to use the equipment or access data, loss of data, loss of business, loss of profits, business interruption or the like) arising out of the use of or inability to use the Hardware even if TomTom has been advised of the possibility of such damages.
- 10) Notwithstanding any damages that you might incur for any reason whatsoever (including, without limitation, all damages referenced herein and all direct or general damages in contract or anything else), the entire liability of TomTom and any of its suppliers shall be limited to the amount actually paid by you for the Hardware.
- 11) Notwithstanding the above, neither party's liability for death or personal injury resulting from its own negligence shall be limited.
- 12) Some states and/or jurisdictions do not allow the exclusion or limitation of incidental or consequential damages, so the above limitations or exclusions may not apply to you.

## 25. Addendum

---

### Important Safety Notices and Warnings

#### Global Positioning System

The Global Positioning System (GPS) is a satellite-based system that provides location and timing information around the globe. GPS is operated and controlled under the sole responsibility of the Government of the United States of America which is responsible for its availability and accuracy. Any changes in GPS availability and accuracy, or in environmental conditions, may impact the operation of your TomTom device. TomTom does not accept any liability for the availability and accuracy of GPS.

#### Use with Care

Use of a TomTom device for navigation still means that you need to drive with due care and attention.

#### Aircraft and Hospitals

Use of devices with an antenna is prohibited on most aircraft, in many hospitals and in many other locations. A TomTom device must not be used in these environments.

#### Battery

This product uses a Lithium-Polymer battery. Do not use it in a humid, wet and/or corrosive environment. Do not put, store or leave your product in or near a heat source, in a high temperature location, in strong direct sunlight, in a microwave oven or in a pressurized container, and do not expose it to temperatures over 60 C (140 F). Failure to follow these guidelines may cause the Lithium-Polymer battery to leak acid, become hot, explode or ignite and cause injury and/or damage. Do not pierce, open or disassemble the battery. If the battery leaks and you come into contact with the leaked fluids, rinse thoroughly with water and seek medical attention immediately. For safety reasons, and to prolong the lifetime of the battery, charging will not occur at low (below 0 C/32 F) or high (over 45 C/113 F) temperatures.

Temperatures: Standard operation: -10 C (14 F) to +55 C (131 F); short period storage: -20 C (-4 F) to + 60 C (140 F); long period storage: -20 C (-4 F) to +25 C (77 F).



THE LITHIUM-POLYMER BATTERY CONTAINED IN THE PRODUCT MUST BE RECYCLED OR DISPOSED OF PROPERLY. USE YOUR TomTom ONLY WITH THE SUPPLIED DC POWER LEAD (CAR CHARGER/BATTERY CABLE) AND AC ADAPTER (HOME CHARGER) FOR BATTERY CHARGING.

To recycle your TomTom unit please see your local approved TomTom service center.

## **SPECIAL NOTE REGARDING DRIVING IN CALIFORNIA AND MINNESOTA**

California Vehicle Code Section 26708 (a) (1) provides that "No persons shall drive any motor vehicle with an object or material placed, displayed, installed, affixed or applied upon the windshield or side or rear windows." Drivers in California should not use a suction mount on their windshield, side or rear windows.

Note: this section of the California Vehicle Code applies to anyone driving in California, not just California residents.

Minnesota State Legislature Statutes Section 169.71, subdivision 1, section 2 provides that "A person shall not drive or operate with any objects suspended between the driver and the windshield other than sun visors and rearview mirrors and electronic toll collection devices."

Note: this Minnesota Statute applies to anyone driving in Minnesota, not just Minnesota residents.

TomTom Inc. bears no responsibility for any fines, penalties or damage that may be incurred by disregarding this notice. While driving in any state with windshield mounting restrictions, TomTom recommends the use of the supplied Adhesive Mounting Disk or its Alternative Mounting Kit, which includes multiple options for mounting TomTom devices on the dashboard and using the air vents. See [www.tomtom.com](http://www.tomtom.com) for more information about this mounting option.

## **FCC Information for the User**



This product contains a transmitter which must not be co-located or simultaneously operated in conjunction with any other transmitter.

### **Exposure to Radio Frequency Radiation**

This device complies with FCC radiation exposure limits set forth for an uncontrolled environment. In order to avoid the possibility of exceeding the FCC radio frequency exposure limits, human proximity to the antenna shall not be less than 20cm (8 inches) during normal operation.

### **Radio and Television Interference**

This equipment radiates radio frequency energy and if not used properly - that is, in strict accordance with the instructions in this manual - may cause interference to radio communications and television reception.

This device has been tested and found to comply with the limits for a Class B digital device, pursuant to Part 15 of the FCC Rules. These limits are designed to provide reasonable protection against harmful interference in a residential installation. This equipment generates, uses and can radiate radio frequency energy and, if not installed and used in accordance with the instructions, may cause harmful interference to radio communications. However, there is no guarantee that interference will not occur in a particular installation. If this equipment does cause harmful interference to radio or television reception, which can be determined by turning the equipment off and on, the user is encouraged to try to correct the interference by one or more of the following measures:

- Reorient or relocate the receiving antenna.
- Increase the separation distance between the equipment and the receiver.
- Connect the equipment into an outlet on a circuit different from that to which the receiver is connected.
- Consult an experienced radio/TV technician for help.

Changes or modifications not expressly approved by the party responsible for compliance could void the user's authority to operate the equipment.

## Important

This equipment was tested for FCC compliance under conditions that included the use of shielded cables and connectors between it and the peripherals. It is important that you use shielded cable and connectors to reduce the possibility of causing radio and television interference. Shielded cables, suitable for the product range, can be obtained from an authorised dealer. If the user modifies the equipment or its peripherals in any way, and these modifications are not approved by TomTom, the FCC may withdraw the user's right to operate the equipment. For customers in the USA, the following booklet prepared by the Federal Communications Commission may be of help: "How to Identify and Resolve Radio-TV Interference Problems". This booklet is available from the US Government Printing Office, Washington, DC 20402. Stock No 004-000-00345-4.

## FCC Declaration of Conformity

### Tested to Comply with FCC Standards for Home or Office Use

FCC ID: S4LGO520  
IC: 5767A-GO520

This device complies with part 15 of the FCC Rules. Operation is subject to the following two conditions:

1. This device may not cause harmful interference.
2. This device must accept any interference received, including interference that may cause undesired operation.

### Responsible party in North America

TomTom, Inc., 150 Baker Avenue, Concord, MA 01742

Tel: 866 486-6866 option 1 (1-866-4-TomTom)

### Emissions information for Canada

This Class B digital apparatus complies with Canadian ICES-003. Cet appareil numérique de la classe B est conforme à la norme NMB-003 du Canada.

## C-tick



**N14644**

This product displays the C-tick to show it complies with all relevant Australian and New Zealand regulations.

## Warning for Australia

The user needs to switch off the device when exposed to areas with potentially explosive atmospheres such as petrol stations, chemical storage depots and blasting operations.

## This Document

Great care was taken in preparing this manual. Constant product development may mean that some information is not entirely up-to-date. The information in this document is subject to change without notice.

TomTom shall not be liable for technical or editorial errors or omissions contained herein; nor for incidental or consequential damages resulting from the performance or use of this material. This document contains information protected by copyright. No part of this document may be photocopied or

reproduced in any form without prior written consent from TomTom International B.V.

**Part numbers**

TomTom GO: 4M00.000, 4M00.001, 4M00.002, 4M00.900, 4M00.002, 4M00.006

## 26. Copyright notices

---

---

© 2007 TomTom International B.V., The Netherlands.

*Patents Pending. All rights reserved.*

*TomTom and the TomTom logo are registered trademarks of TomTom International B.V., The Netherlands. All other trademarks are the property of their respective owners.*

*Our end user license agreement and a limited warranty apply to this product; they are included in this package. You can also review both at [www.TomTom.com/legal](http://www.TomTom.com/legal)*

---

---

### *Data Source*

© 1984 – 2007 Tele Atlas North America, Inc. All rights reserved.

*Canadian data © DMTI Spatial. Portions of Canadian map data are reproduced under license from Her Majesty the Queen in Right of Canada with permission from Natural Resource Canada. Point of Interest data by Info USA. Copyright 2007.*

---

---

### *Data Source*

© Whereis® 2007 UBD® and Sensis® are trademarks of Telstra® Corporation Limited, used under license.

---

---

*Text to Speech technology, © 2007 Loquendo TTS. All rights reserved. Loquendo is a registered trademark. [www.loquendo.com](http://www.loquendo.com)*

---

---

*Apple® and iPod® are trademarks of Apple Computer, Inc., registered in the U.S. and other countries.*

---

---

*Audible®, AudibleListener® and Audiblemanager® are registered trademarks of Audible, Inc. When purchasing and using Audible content you need to agree to the terms and conditions as posted in the Legal Notices [www.audible.com](http://www.audible.com).*

---

---

*SoundClear™ acoustic echo cancellation software © Acoustic Technologies Inc.*

---



---

*MPEG Layer-3 audio coding technology licensed from Fraunhofer IIS and Thomson.*

*Supply of this product does not convey a license nor imply any right to distribute content created with this product in revenue-generating broadcast systems (terrestrial, satellite, cable and/or other distribution channels), streaming applications (via Internet, intranets and/or other networks), other content distribution systems (pay-audio or audio-on-demand applications and the like) or on physical media (compact discs, digital versatile discs, semiconductor chips, hard drives, memory cards and the like). An independent license for such use is required. For details, please visit [mp3licensing.com](http://mp3licensing.com)*

---

---

*Some images are taken from NASA's Earth Observatory.*

*The purpose of NASA's Earth Observatory is to provide a freely-accessible publication on the Internet where the public can obtain new satellite imagery and scientific information about our home planet.*

*The focus is on Earth's climate and environmental change:  
[earthobservatory.nasa.gov/](http://earthobservatory.nasa.gov/)*

---